

# Union Ranch Specific Plan

Manteca, California



Updated March 2012



Prepared by  
**The HLA Group**  
Landscape Architects and Planners, Inc.

Prepared For: **Union Ranch Partners, LLC**  
Manteca, California

**Pulte Home Corporation**  
Pleasanton, California

Project Coordinators: **RLC Associates**  
Manteca, California

Land Planner/Specific Plan: **The HLA Group Landscape Architects & Planners, Inc**  
Sacramento, California

Civil Engineer: **Thompson-Hysell Engineers**  
Modesto, California

Geotechnical Engineer: **Kleinfelder, Inc.**  
Stockton, California

Traffic Engineering: **kdAnderson Transportation Engineers**  
Loomis, California

Environmental Engineering: **EDAW**  
Sacramento, California

---

Section A. Specific Plan Summary	1
A.1 Introduction	1
A.2 Project Setting and Regional Context	3
A.3 General Plan Consistency	5
A.4 Development Approvals	5
A.5 California Environmental Quality Act Compliance	5
Section B. Objectives of the Specific Plan	6
Section C. Land Use	8
C.1 Land Use Strategy	8
C.2 Land Use Goals	8
C.3 Land Use Summary	10
Table C.3.1 Land Use Summary	12
Table C.3.2 Lot Summary	13
C.4 Permitted Uses and Development Standards	16
Table C.4.1 Permitted Land Use Summary	16
Table C.4.2 Development Standards	21
C.5 Housing Element	25
C.6 General Plan Consistency	25
C.6.1 Community Design	26
C.6.2 Housing Element - General Plan Consistency	32
C.6.3 Circulation Element	34
C.6.3a Street System	34
C.6.3b Traffic Safety	37
C.6.3c Parking	38
C.6.3d Transportation Alternatives	38
C.6.4 Air Quality Element	40
C.6.5 Resource Conservation Element	41
C.6.5a Water Quality	41
C.6.5b Energy Conservation	42
C.6.5c Soils and Erosion Control	43

---

C.6.5d Water Quality	43
C.6.5e Open Space	43
C.6.5f Agricultural Resources	44
C.6.5g Biological Resources	45
C.7 Special Lot Provision	47
Section D. Circulation	48
D.1 Existing Right-of-Ways	50
D.2 Proposed Right-of-Ways	55
D.3 Non-Vehicular Circulation	61
D.4 Public Transit	62
Section E. Public Facilities	63
E.1 Police Protection/Law Enforcement	63
E.1.1 Law Enforcement Standards	63
E.2 Fire Protection	64
E.2.1 Fire Protection Standards	64
E.3 Solid Waste Disposal	64
E.3.1 Solid Waste Disposal Standards	64
E.4 Park Facilities	64
Table E.4.1.1 Open Space & Park Amenities	65
E.4.1 Park Financing, Dedication and Maintenance	67
E.4.2 Private Recreation Facilities	68
Section F. Infrastructure	69
F.1 Water Master Plan	69
F.2 Sanitary Sewer Master Plan	69
F.3 Storm Drain Master Plan	74
F.4 Telephone	80
F.5 Electricity	80
F.6 Natural Gas	80
F.7 Cable Television	80

---

Section G. Resource Planning	81
G.1 Biological Resources	81
G 1.1 Wetlands	81
G 1.2 Terrestrial Biology	81
G 1.3 Biological Resource Guidelines and Standards	82
G.2 Water Quality	83
G.2.1 Water Quality Resource Guidelines and Standards	83
G.2.2 Proposed Lake Uses	83
G.2.3. Lake Physical Characteristics and Irrigation Reservoir	83
G.2.4 Lake Water Quality Management System(s) and Vector Control Plan	84
G.2.5 Lake Access and Public Safety	85
G.2.6 Operations and Maintenance (O&M) Program	85
G.2.7 Lake System – Water Quality Management Program	86
G.3 Cultural Resources	87
G.3.1 Regulatory Framework and Thresholds	87
G.3.2 Cultural Resource Standards and Guidelines	88
Section H. Phasing and Financing	89
H.1 Development Agreement	89
H.2 Phasing of Improvements	89
H.2.1 Description of Major Infrastructure Improvements	91
H.3 Cost of Improvements	93
Table H.3.1 Engineer’s Opinion of Probable Costs, Union Ranch Off-Site Improvements	94
Section I. Implementation and Administration	96
I.1 Implementation of the Plan	96
I.2 Annexation	96
I.3 Adoption of the Specific Plan	97
I.4 Plan Review and Amendments	97
Section J. Design Guidelines	99
J.1 Introduction	99
J.2 Residential Design Guidelines	101

---

J.2.1 Woodbridge by Del Webb Residential Design Character	101
J.2.2 Woodbridge by Del Webb Residential Design Criteria	102
J.2.3 Union Ranch East and CMU Residential Design Character	103
J.2.4 Union Ranch East Design Criteria	104
J.2.5 CMU Residential Design Criteria	105
J.3 Commercial Mixed-Use Design Guidelines	106
J.3.1 Commercial Parking Guidelines	107
J.4 Open Space Design Guidelines	108
J.5 Landscape Concept	109
J.6 Landscape Easements and Open Space	109
J.7 Streetscapes	110
J.8 Streetscape Elements	114
J.9 Signage	121
J.10 Decorative or Enhanced Paving	126
J.11 Streetscape Furnishings	126
J.12 Public Lighting	127
J.13 Soundwalls	127
J.14 Pilasters and Low Decorative Walls	129
J.15 Fencing	130
J.16 Landscape Palette	131
J.16.1 Master Plant Palette	131
J.17 Soil Conditioning Guidelines	131
J.18 Irrigation Improvements Criteria	131
J.19 Landscape Maintenance	132
J.19.1 Turf Care	132
J.19.2 Tree and Shrub Care	133
J.19.3 Ground Cover Care	134
J.19.4 Annual Flower Beds	135
J.19.5 Irrigation System	135
J.19.6 Hardscape Care	135

Appendix A.1	136
Streetscape Plantings	136
Clubhouse Planting	138
Front Yard Typical Planting	140

---

Figure A.2.1 Regional Context Map	3
Figure A.2.2 Vicinity Map	4
Figure C.1.1 Land Use Map	11
Figure C.1.2 Land Use Zone Map	15
Figure C.4.3 46X98 Foot Lot	22
Figure C.4.4 51X98 Foot Corner Lot	22
Figure C.4.5 55X98 Foot Lot	22
Figure C.4.6 60X98 Foot Corner Lot	22
Figure C.4.7 75X98 Foot Lot	23
Figure C.4.8 80X98 Foot Corner Lot	23
Figure C.7.1 DeGroot Lot	47
Figure D.1.1 Circulation Diagram	49
Figure D.1.2 Arterial Road - Lathrop CMU Frontage, Section A	50
Figure D.1.3 Arterial Road - Lathrop Multi-use Trail Frontage, Section B	51
Figure D.1.4 Arterial Road - Union Road South of Community Entry, Section C	51
Figure D.1.5 Arterial Road - Union Road South of Community Entry, Section D	52
Figure D.1.6 Arterial Road - Union Road South of Community Entry, Section E	52
Figure D.1.7 Arterial Road - Union Road North of Community Entry, Section F	53
Figure D.1.8 Arterial Road - Airport Way South of Woodbridge Entry, Section G	53
Figure D.1.9 Arterial Road - Airport Way North of Woodbridge Entry, Section H	54
Figure D.2.1 Residential Collector - Union Ranch East, Section I	55
Figure D.2.2 Neighborhood Street - Union Ranch East, Section J	56
Figure D.2.3 Neighborhood Street at Tidewater Trail- Union Ranch East, Section K	56
Figure D.2.4 Major Residential Collector Street - Woodbridge by Del Webb, Section L	57
Figure D.2.5 Cul-de-Sac Street - Woodbridge by Del Webb, Section M	57
Figure D.2.6 Neighborhood Street at Parkway - Woodbridge by Del Webb, Section N	58
Figure D.2.7 Neighborhood Street - Woodbridge by Del Webb, Section O	58
Figure D.2.8 Neighborhood Street at Parkway - Woodbridge by Del Webb, Section P	59
Figure D.2.9 Residential Collector Street - Woodbridge by Del Webb, Section Q	59
Figure D.2.10 Collector Street w/Soundwall on 2 Sides- Woodbridge by Del Webb, Section R	60

---

---

Figure D.2.11 Collector Street w/Soundwall on 1 Side- Woodbridge by Del Webb, Section S	60
Figure D.2.12 Collector Street w/Parking on 2 Sides - Woodbridge by Del Webb, Section T	61
Figure D.3.1 Bike Trail - Rear Yard, Section U	61
Figure E.4.1.1 Park Site A	66
Figure E.4.1.2 Park Site B	66
Figure E.4.1.3 Park Site C	67
Figure E.4.2.1 Recreational Center	68
Figure F.1.1 Master Water Plan	71
Figure F.2.1 Partial City Sewer Plan	72
Figure F.2.2 Master Sewer Plan	73
Figure F.3.1 Existing Drainage	76
Figure F.3.2 Storm Drain Basin Master Plan	77
Figure F.3.3 Master Storm Drain Plan	78
Figure F.3.4 Master Storm Drain Plan	79
Figure H.1.1 Phasing Diagram	95
Figure J.1.1 Neighborhood Character	99
Figure J.2.1 Typical Single Family Home	103
Figure J.2.2 Typical Single Family Home	105
Figure J.3.1 Typical Multi-Family Home	107
Figure J.3.2 Typical Parking Screen	108
Figure J.3.3 Typical Parking Island Planter	108
Figure J.4.1 Typical Drainage Section	109
Figure J.7.1 Typical Arterial Street Section	111
Figure J.7.2 Typical Arterial Street Section	111
Figure J.7.3 Typical Arterial Street Section	111
Figure J.7.4 Typical Collector Street Section	112
Figure J.7.5 Typical Residential Street Section	113
Figure J.7.6 Typical Residential Street Section	113
Figure J.7.7 Typical Multi-Use Path Section	114
Figure J.8.1 Entry and Gateway Map	115

---

---

Figure J.8.2 Major Community Entry Plan View	116
Figure J.8.3 Major Community Entry Section	116
Figure J.8.4 Primary Woodbridge Entry Plan View	117
Figure J.8.5 Primary Woodbridge Entry Section	117
Figure J.8.6 Primary Union Ranch Entry Plan View	118
Figure J.8.7 Primary Union Ranch Entry Section	118
Figure J.8.8 Secondary Woodbridge Entry Plan View	119
Figure J.8.9 Secondary Woodbridge Entry Section	119
Figure J.8.10 Secondary Union Ranch Entry Plan View	120
Figure J.8.11 Secondary Union Ranch Entry Section	120
Figure J.9.1 Major Community Entry Signage	121
Figure J.9.2 Primary Woodbridge Community Entry Signage	121
Figure J.9.3 Primary Union Ranch Community Entry Signage	122
Figure J.9.4 Secondary Woodbridge Community Entry Signage	122
Figure J.9.5 Secondary Union Ranch Community Entry Signage	123
Figure J.9.6 Major Commercial Signage	123
Figure J.9.7 Freestanding Commercial Signage	124
Figure J.9.8 Gas Station Signage	124
Figure J.9.9 Traffic Signs	124
Figure J.11.1 Site Furnishings	126
Figure J.12.1 Street Lights	127
Figure J.13.1 Soundwalls	127
Figure J.13.2 Soundwall and Fencing Map	128
Figure J.14.1 Soundwall and Pilaster Diagram, Plan & Section	129
Figure J.15.1 Decorative View Fence	130
Figure J.15.2 Low Accent Fencing	130
Figure J.15.3 Front, Side Yard, and Rear Fence	130

## Section A. Specific Plan Summary

### A.1 Introduction

The Union Ranch Specific Plan provides a comprehensive and orderly guideline for the development of 552.73 acres of new residential and commercial development within the City of Manteca-- all in concert with the 2023 General Plan. The Specific Plan proposes 1,922 single-family dwelling units in two distinct communities linked thematically with a common landscape, common bike and pedestrian trails, and a common materials palette for walls, fences and entry monuments. The plan area also includes a 38.9-acre commercial development fronting Lathrop Road which provides for a possible addition of 341 multi-family housing units. Of the total Plan Area, 302.92 acres shall be devoted to an active adult housing community, developed by Pulte Home Corporation as Woodbridge by Del Webb. The active adult community will be comprised of 1,425 single-family dwelling units, and will include a recreation center, parkland, open space and access to commercial uses. The remaining 249.81 acres devoted to residential uses will contain 497 traditional single-family dwelling units, as well as parkland, open space, as well as an extension of and access to the Tidewater Trail.

The Specific Plan is designed to provide a clear development program for the area it covers. This will be achieved by establishing the framework that will support development and ensure consistency within the Plan Area. The Specific Plan also outlines a program for providing supportive facilities and services and an implementation schedule to provide those services to meet development timelines. The Specific Plan addresses General Plan conformance in Section C, with reference to Circulation, Air Quality, Housing, Open Space and Conservation, and Community Design.

Specific Plans are authorized in Section 65450 of the California Government Code and are intended to provide the City of Manteca a review standard for evaluating various applications that come before it, for projects within the Plan Area. It also provides landowners with the requirements for their own design team to utilize when preparing specific site developments within the Plan Area, and to meet a minimum standard threshold while encouraging a consistent design theme.

Section 65450 requires the following information in a Specific Plan.

- a) Text and diagram which specifies the following:
  1. Distribution, location, and extent of the uses of land.
  2. Proposed distribution, location, and extent and intensity of major components of public and private transportation, sewage, water, drainage, solid waste disposal, energy, and other essential facilities proposed to be located within the area covered by the Plan and required to complete the Plan.
  3. A plan to implement the Plan including regulations, public projects, and financing necessary to carry out the Plan.
  4. Standards by which development will proceed, and standards for conservation and utilization of natural resources where this can be achieved.
- b) The relationship of the Specific Plan to the General Plan shall be stated.

This Specific Plan is divided into ten sections as outlined in the Table of Contents. Each of these Sections is to be used as a building block to meet the goals of Section 65450 of the California Government Code. The sections are summarized as follows:

Section A. Specific Plan Summary provides a brief overview of the planning area and planning process with sub-sections to discuss the project setting and regional context, development approvals and CEQA compliance.

Section B. Objectives of the Specific Plan provides a general description of the goals and objectives of the Plan relative to land use, circulation, housing, open space, community design, and public facilities.

Section C. Land Use provides a further definition of the land use strategy and land use goals, and lists policies and development standards, as well as General Plan conformance for each land use.

Section D. Circulation provides an overview of the proposed transportation system including roadways, bikeways and walkways. Section D. illustrates typical improvements to new and existing right-of-ways.

Section E. Public Facilities discusses the law enforcement, fire, emergency services, parks and parkway elements of the Plan Area. This section identifies the proposed locations for public facilities and service ratios for the Plan Area.

Section F. Infrastructure summarizes the proposed systems for sewer, water and drainage. Detailed engineering studies have been prepared in support of the proposed land uses and will need to be periodically reviewed, revised, augmented and updated as detailed subdivision plans are submitted and approved.

Section G. Resource Planning summarizes potential environmental issues and lists policies and standards to mitigate for impacts to natural resources in the Plan Area. This includes but is not limited to: water quality, air quality, wildlife, vegetation, and cultural resources.

Section H. Phasing and Financing summarizes the phasing of the backbone infrastructure and roadways. This includes a brief summary of construction costs for utilities and major improvements required for the project, as well as those benefiting the public at large.

Section I. Implementation and Administration describes the process by which subsequent submittals, or if necessary-- amendments to the Plan, are made.

Section J. Design Guidelines discusses the general parameters of community design including the selection of materials, finishes, plant palettes, and the arrangements of built objects such as signage, monuments and fencing. The design guidelines present the overall look and feel of the Plan Area, and provide development policies that establish control over the design of the community.

Five major master plans are found within the Specific Plan, covering Land Use, Circulation, Public Facilities, Infrastructure, and Design Guidelines. Collectively these master plans form the foundation the Specific Plan, and as a whole they set the criteria, design requirements, and performance standards for the creation of the Union Ranch Planning Area.

## A.2 Project Setting and Regional Context

Union Ranch adjacent to the northern limits of the City of Manteca, San Joaquin County, California. Manteca is located 60 miles south of the City of Sacramento (the State Capital), 90 miles east of San Francisco, and 45 miles West of the Yosemite Valley. This places Manteca in the heart of California's Central Valley with its level terrain gently sloping towards the west and the San Francisco Bay delta. The City and surrounding region has a rich agricultural history which is visually evident in the grid formed pattern of urban Manteca. The City is flanked by Interstate 5 to the west and bisected by Highway 99 to the east, each a major north-south transportation corridor; access to San Francisco is provided via Route 120.

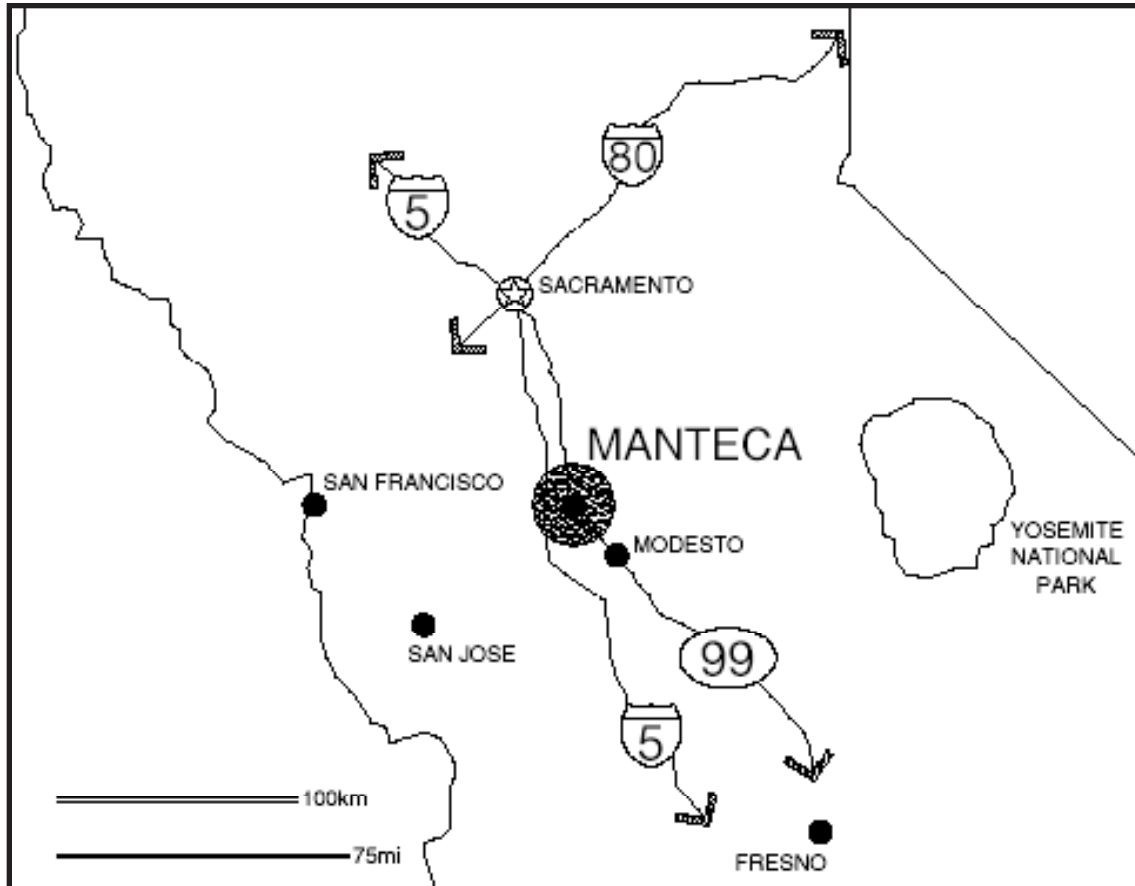

Figure A.2.1 Regional Context Map

The Union Ranch specific planning area is located north of Lathrop Road, which runs in an east-west direction linking Interstate 5 and Highway 99. The plan area itself is bisected by Union Road in a north-south direction. Union Road acts as a major link between Central Manteca and the town of French Camp. In 2003 the land area in which Union Ranch is located was included in the 2023 General Plan.

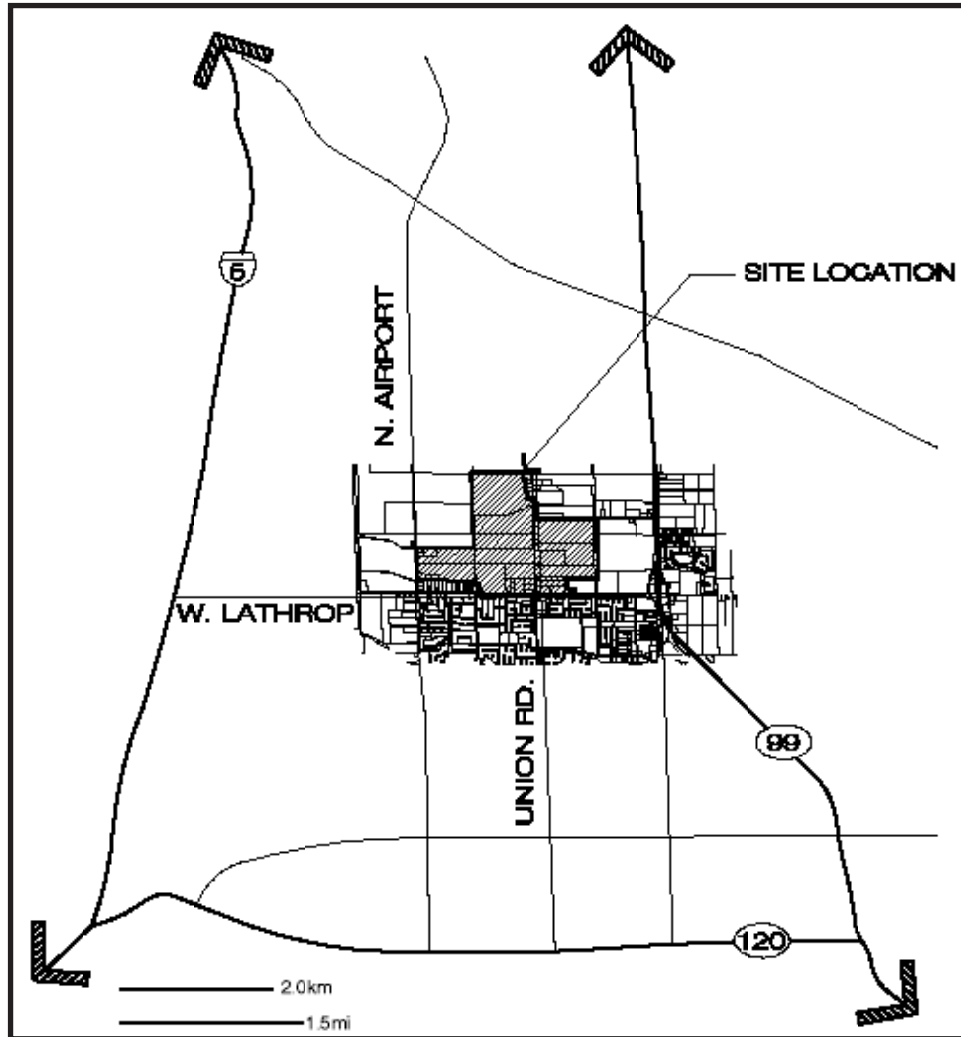

Figure A.2.2 Vicinity Map

Existing vegetation is chiefly agricultural in nature with the majority of visible plant material being fruit bearing orchard trees. A few large native Oaks are located to the northeast of the Union Road-Lathrop Road intersection. Existing residences located in the planning area are associated with the on-site farming activities. An existing hay/supply business is located on the northwest corner of the Union Road-Lathrop Road intersection. The balance of the plan area has been previously, or is currently, farmed.

South of Lathrop Road, at the southwest corner of Union- Lathrop Road, is a neighborhood retail center with a major chain supermarket; the southeast corner of the same intersection is zoned HDR and is partially improved with a new senior apartment complex. Other surrounding land uses to the north and west are agriculturally based. A few large lot residential parcels are to the north of the plan area fronting Union Road. To the East is the existing right-of-way of the Tidewater Railroad. It is currently utilized as a pedestrian/bicycle path south of Lathrop Road, extending to the central business district of Manteca. Delta College owns a large parcel to the east that is utilized for experimental agriculture with some classroom activity housed in a small existing building. The balance of adjacent parcels is dominated by typical single-family residential uses.

### A.3 General Plan Consistency

The City of Manteca General Plan 2023 was adopted in October 2003 and it includes a larger General Plan area including all of the Union Ranch Specific planning area. The Specific Plan has been prepared to be in conformance to the General Plan.

### A.4 Development Approvals

The approvals requested for this plan area as part of this Specific Plan include rezoning, tentative subdivision maps, utility and infrastructure master plans, development agreements, design guidelines, and associated environmental review.

The Union Ranch Specific Plan has been prepared pursuant to the provisions of the California Government Code, Title 7, Division 1, Chapter 3, Article 8, and Sections 65450 through 65457. The Code authorizes the City to adopt Specific Plans by resolution. Any subsequent development plans or agreements, tentative subdivision or parcel maps, and any other development approval must be consistent with the Specific Plan. Projects that are consistent with the Specific Plan will inherently be deemed consistent with the City's General Plan.

The Specific Plan is to provide a vehicle for implementing the City's General Plan on an area specific basis.

### A.5 California Environmental Quality Act Compliance

All discretionary land use entitlement approvals associated with the implementation of the Specific Plan shall be subject to environmental review as required by the California Environmental Quality Act. An EIR covering all of the proposed land use applications and their associated environmental effects will be prepared by an independent consultant and incorporated into this plan by reference.

The California Environmental Quality Act requires identification of mitigation measures that may be incorporated into the approval of the project to lessen or eliminate significant environmental effects. It also requires a program of mitigation monitoring and reporting to assess the effectiveness of the mitigation measures. Such a program will be established for the Union Ranch Specific Planning Area.

## Section B. Objectives of the Specific Plan

The Union Ranch Specific Plan has been designed as a clear development program for the area it covers and is supportive of the General Plan of the City of Manteca. The goals and policies of that General Plan have been addressed and a land use plan has been created that reflects the individuality of the Union Ranch Plan Area while supporting a development that will form the logical extension of urbanized Manteca. This individuality sets a high standard for community planning and design, anchoring the northern edge of the urban development envisioned by the 2023 General Plan. The attributes of the General Plan helped to determine the precise objectives of the Union Ranch Specific Plan and these objectives are itemized as follows:

### Objective 1. Land Use

- Provide residential communities, within the City of Manteca, with supporting commercial, open space, and public facilities.
- Provide a range of housing types within the proposed residential framework proposed by the Specific Plan.
- Provide appropriate design and buffers between uses in the Plan.
- Provide alternative access patterns, incorporating bicycle and pedestrian circulation.
- Integrate the planning area within the existing urban fabric of the City of Manteca.

### Objective 2. Circulation

- Provide a safe and efficient circulation system for pedestrians, bicyclists and automobile traffic.
- Provide for future and current resident's requirements to provide adequate levels of service.
- Reduce bicycle/pedestrian conflict with the automobile.
- Provide safe and walkable communities.
- Conform to City Standards while introducing new community-based enhancements.

### Objective 3. Housing

- Build upon the historical context of Manteca's housing stock.
- Provide a variety of housing options specific to the development programs proposed, including active adult and traditional single-family residential housing.
- Develop identifiable neighborhoods.
- Encourage and require energy conservation in the site planning and design of units.
- Encourage high quality materials throughout the Plan area.

- Provide ease of visual observation in the designs of units to secure the neighborhood in which they are located.

Objective 4. Open Space

- Establish a public open space system that is easily accessible to all residents of the Plan Area, exclusive of any private recreation facility.
- Open space areas shall be located to encourage maximum visibility for self-policing.
- Provide active and passive needs of the residents with a diversity of recreational opportunities.
- Bicycle and pedestrian paths shall link neighborhoods to commercial developments, parks and open space and the surrounding community.

Objective 5. Community Design

- Develop a comprehensive project theme that unifies the plan area while providing distinct and identifiable development opportunities for Woodbridge by Del Webb as well as the traditional residential development of Union Ranch East.
- Integrate the plan area into the existing urban fabric by reflecting the heritage of Manteca.
- Develop Design Guidelines which establish criteria for all land use features, whether public improvements, or on site developments, to address landscape; signage; architecture; parking; lighting; site furnishing; and similar visual built environments.
- Develop an enforceable program to insure conformance to the Design Guidelines.
- Encourage energy efficient design solutions in the built product.
- Encourage pedestrian plazas and group gathering areas within commercial use areas.

Objective 6. Public Facilities

- Develop a strong pedestrian and bicycle circulation plan.
- Ensure adequate public facilities to minimize impact on existing public infrastructure.
- Develop an appropriate phasing plan.
- Right of way improvements that include landscape infrastructure.
- Easily accessible access in distance and conveyances to provide public education

## Section C. Land Use

### C.1 Land Use Strategy

The Union Ranch Specific Plan Area is approximately five hundred and fifty acres located north of Lathrop Road and bisected by Union Road. The site is generally flat with a gentle slope to the west. The existing land use is, or has been, chiefly agricultural in nature. Similarly, adjacent land uses to the north and east are currently used for agricultural purposes, with industrial uses located to the west. To the south there is urbanized Manteca with more intensive development, including commercial, residential, and public/quasi public land uses.

The strategy of the Specific Plan is to develop a residential community that supports the logical extension of the existing developed portion of the City of Manteca. The organizing principal of the land use designations in the planning area is the arrangement of two residential neighborhoods—one designed as an age restrictive active adult community known as Woodbridge by Del Webb, and the other as a traditional single-family development known as Union Ranch East. The defining character of each will be a shared relationship to open space and parkland, and a strongly defined circulation system with a common landscape theme.

The Plan respects the existing commercial hub that exists at two major right-of-ways by placing Commercial Mixed Use Plan designations on the northeast and northwest corners of the Union Road/Lathrop Road intersection. The Plan expands upon existing Public / Quasi-Public lands by allowing expansion of the existing church facility to the north of its current property line. An east-west Pedestrian/Bicycle Open Space Corridor links to an open space corridor that transverses north-south to provide seamless access to common areas and open space corridors throughout the Plan Area. In addition, the Plan preserves the Tidewater Open Space Corridor on the East side to connect to the existing corridor south of Lathrop Road. The Plan has also been designed with enhanced right-of-ways to improve and encourage pedestrian/bicycle access internally within the Plan Area, and to connect to the existing urban fabric of greater Manteca. (See Figure C.1.1) The strategy is to have designated land uses, with distinct development arrangements, but commonly linked through a landscaped-based design program.

### C.2 Land Use Goals

The Union Ranch Specific Plan is intended to create two vibrant and distinct communities within a single planning area. The design of each shares a common community theme in material and plant palettes, a shared circulation system with access to arterial roadways and public bike and pedestrian pathways, as well as a shared access to the proposed commercial mixed-use development located along Lathrop Road. The differences between the two residential communities shall be defined by the demographic mix of the residents and housing product types found in each community.

---

The western portion of the Plan Area, totaling approximately 356 acres will be developed by Pulte Home Corporation as an active adult community known as Woodbridge by Del Webb. Land use goals specific to Woodbridge are as follows:

- Establish a community that can provide for the special social, recreational and housing needs for active adults who share common interests and lifestyles.
- Enhance living spaces by integrating the natural and built environments.
- Provide recreational amenities that include dynamic and passive activities with an emphasis on the design of landscape spaces that encourage interaction between residents, with ease of access by bike or on foot to recreational amenities.
- Maximize the potential for energy conservation through building and landscape design and orientations that recognize the climatic conditions of the area.
- Include a mix of housing styles on varying lot sizes that reflect the desires of the active adult marketplace.
- Establish a community that is safe for residents and buffered from noise and traffic and other nuisance factors.
- Integrate residential and non-residential uses through a highly developed landscape, and provide bicycle and pedestrian paths to encourage a minimized use of the auto for shopping and leisure activities.
- Set a high standard for design for both architecture and landscaping with guidelines that will assure quality and compatibility throughout the Plan Area.
- Include visual landmarks in the form of prominent buildings, formal landscape corridors along major streets, and permanent views through open space corridors to provide visual orientation within the community.

The eastern portion of the Plan Area, known as Union Ranch East, shall be developed as a traditional single-family residential community, but with an emphasis on access to open space and parkland. Union Ranch East shall have a highly developed community theme based in a comprehensive palette of entry monuments, walls and fences, and landscape corridors. A summary of land use goals specific to Union Ranch East are as follows:

- Enhance living spaces by integrating the natural and built environments.
- Provide a community that emphasizes the design of landscape spaces that encourage interaction between residents, with ease of access by bike or on foot to recreational amenities.
- Maximize the potential for energy conservation through building and landscape design and orientations that recognize the climatic conditions of the area.
- Establish a community that is safe for residents and buffered from noise and traffic and other nuisance factors.
- Set a high standard for design for both architecture and landscaping with guidelines that will assure quality and compatibility throughout the Plan Area.
- Integrate residential and non-residential uses through a highly developed landscape, and provide a bicycle and pedestrian paths to encourage a minimized use of the auto for shopping and leisure activities.

---

The southern portion of the Plan Area shall be developed as a commercial mixed-use environment anchored by the intersection of Union and Lathrop Roads. Totally approximately 40-acres, the CMU designated parcels are bisected by Union Road and will be accessible from Union Ranch East and Woodbridge by Del Webb by vehicles, bicyclists and pedestrians. A summary of land use goals specific to the Commercial Mixed Use parcels are as follows:

- Integrate a vibrant commercial mixed-use development into the residential development by providing access for pedestrians, bicycle and electric vehicles.
- Integrate a mix of compatible uses on a single site(s) that include sales, services and activities that adjacent residents might require on a daily basis.
- Reduce vehicle trips for adjacent residents by connecting directly to multi-use paths and dedicated bike lanes.
- To provide a variety of services that include housing, retail and office opportunities built around an architectural and landscape theme common to the planning area.
- To provide opportunities for sustainable economic development at the intersection of Lathrop and Union Roads.
- Provide a vibrant and attractive gateway to the planning area.

### C.3 Land Use Summary

The following subsection provides a general summary and description of different land use categories within the Plan Area and the permitted uses and development standards for each land use designation. Also described is the location of the land uses and any special design considerations applied to their proposed arrangement. The Specific Plan applies development standards that are modified, in some instances, from the Manteca Municipal Code, Title 17, Zoning. The land uses are consistent with the Land Use designations of the 2023 General Plan with modifications proposed to apply a mix of housing types defined by lot size and the character of the different neighborhoods found in Woodbridge and Union Ranch East.

For the purposes of the Specific Plan, the modifications in the permitted uses and development standards the suffix "WB" is attached to the zoning category in the Woodbridge by Del Webb portion of the Plan Area. Similarly, the suffix "UR" is attached to the zoning category in the Union Ranch East portion of the Plan Area.

Figure C.1.1 shows the proposed land use zoning. The Plan has followed the Land Use Classifications of the 2023 General Plan with the following description of each:

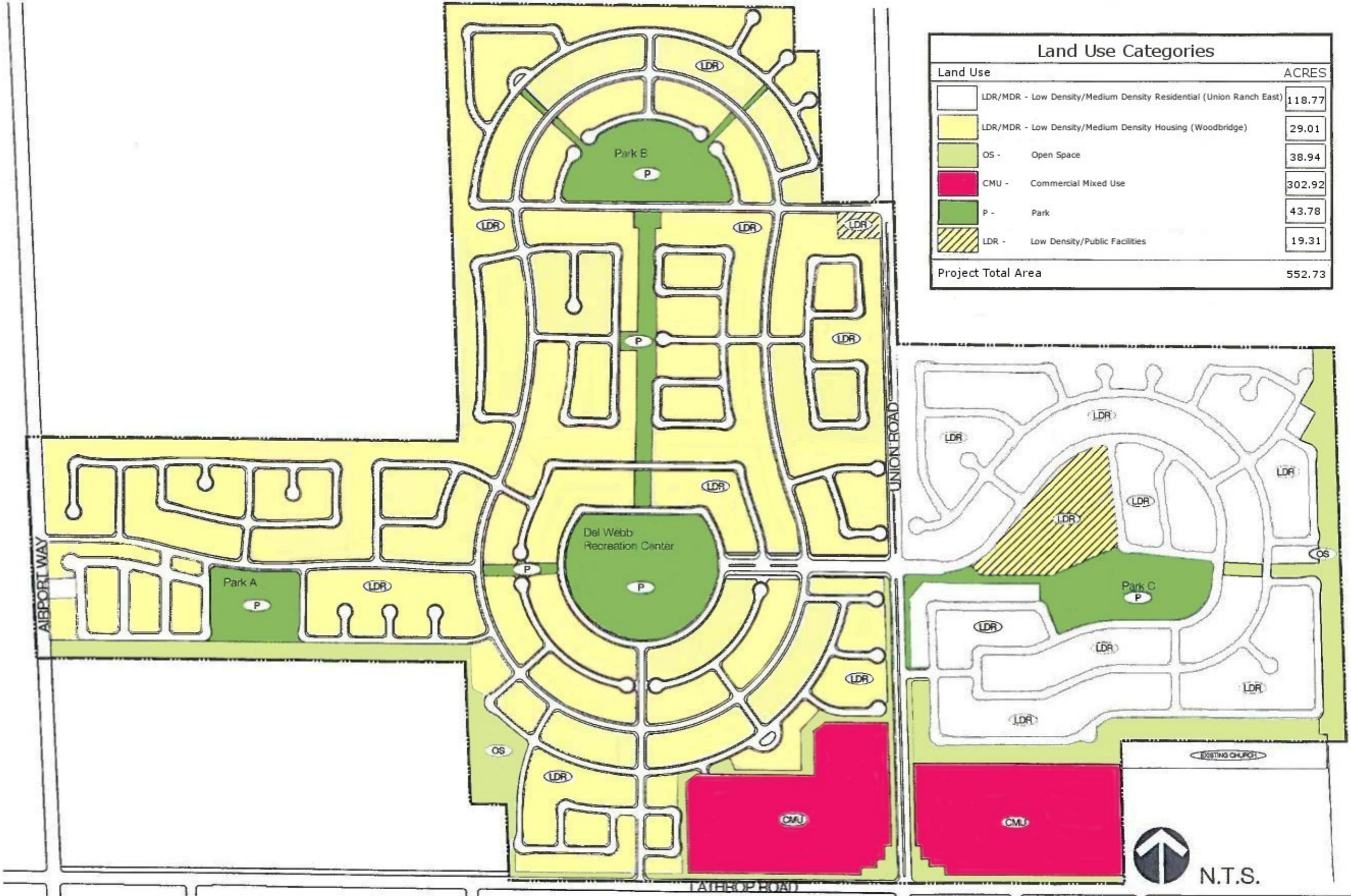

Figure C.1.2 Land Use Zone Map

Table C.3.1 Land Use Summary

GENERAL PLAN DESIGNATION	LAND USE	# OF DWELLING UNITS	% OF TOTAL	TOTAL ACREAGE	% OF SITE	DENSITY RATIO
Commercial/Mixed-Use-HDR	CMU	341	N/A	38.94	7%	
Low Density Residential-Union Ranch East Minimum Lot Size: 6,600 sf.	R-1-6 UR	497	26%	118.77	21%	
Low Density Residential-Del Webb Lot Size: 7,500 + sf.	R-1-WB	403	21%	109.15	20%	
Low Density Residential-Del Webb Lot Size: 5,500-7,499 sf.	R-1-WB	622	32%	118.20	21%	
Low Density Residential-Del Webb Lot Size: 4,600-5,499 sf.	R-1-WB	400	21%	75.57	14%	
Open Space/Trails	OS	N/A	N/A	29.01	5%	
Park	P	N/A	N/A	43.78	8%	
Major R/W's*	N/A	N/A	N/A	9.31	2%	
LDR - Public Facility Proposed Fire Station	R-1	N/A	0%	1.0	0.0018%	
LDR - Public Facility Proposed Elementary School	R-1	N/A	N/A	9.0	0.0182%	
Total		2,263		552.73	100%	4.16du/ ac

\* Major R/W's include the portions of Airport Way, Lathrop Road, and Union Road outside the residential and commercial use areas.

#### Low Density Residential (LDR)

The Union Ranch Specific Plan Area provides Low Density Residential development in two separate communities. The low density residential development portion of the planning area accounts for 78% percent of the total Plan Area with 1,425 single-family active adult units, and 497 traditional single-family units. The Low Density designation in the 2023 General Plan provides for conventional neighborhoods of single-family residences with densities of 2.1 to 8.0 dwelling units per acre.

The Specific Plan envisions two unique primarily residential environments, each with a variety of architectural styles, and lot configurations. The total population for the entire planning area is estimated to be approximately 5,150 persons, with 2,565 residents estimated for Woodbridge by Del Webb (WB)--assuming 1.8 dwellers per household, and 1,664 residents estimated for the Union Ranch East. All parcels shall be adjacent to an open space, or simple walking distance to one via a circulation system of landscape corridors or enhanced right-of-ways. This system serves to connect all the residential developments to each other, to the surrounding land uses and to existing community services.

The Union Ranch Specific Plan provides for an overall single residential density average of 4.16 dwelling units per acre. A variety of single-family detached housing types will be provided with varied lot sizes to provide a variety of housing product types. Therefore, the Specific Plan provides for modified setbacks in the single-family residential zone and provides a modified average lot size to accommodate a variety of housing types. A summary follows in Table C.3.2

Table C.3.2 Lot Summary

APPLICABLE ZONES	LOT DIMENSION	SQFT.	% OF TOTAL	TOTAL UNITS
R-1-6 UR (LDR)	60' X 110'	6,600	26%	497
R-1-WB (LDR)	75' X 98'	7,500 +	21%	403
R-1-WB (LDR)	55' X 98'	5,500-7,499	32%	622
R-1-WB (LDR)	46' X 98'	4,600-5,499	21%	400
TOTALS			100%	1,922

---

### Commercial-Mixed Use (CMU)

The Commercial Mixed Use Plan Area totals 38.9 acres and is located at the intersection of Union Road and Lathrop Road. This Land Use will be designed to maximize non-vehicular access from the surrounding land uses while facilitating vehicular access in an unobtrusive form.

This area is designed to be the centralized hub of commercial and office component of the plan area. The CMU designation does not preclude high-density housing, which may be accommodated on 35% of the CMU designated land area at densities of 15.1 to 25 dwelling units per acre. Allowing for approximately 341 units and 921 residents as calculated at 2.7 persons per unit. The land designated CMU shall be intended to primarily service the Plan Area, with a minor role of serving the existing surrounding land uses. The components of the CMU development will distinguish it from conventional neighborhood commercial or office developments by establishing internal traffic circulation and access control, and by minimizing driveway conflicts. Additionally, it may include:

- Space for community activities within the center.
- On-site storm water detention facilities designed as a landscape amenity.
- Public facilities where feasible, such as a post office, library, fire station or satellite government office.
- A neighborhood work center as defined in the General Plan.
- A shared parking program for the different uses.
- Refer to Table C.4.1 for a complete list of permitted uses.

The characteristics of the CMU development will include a strong architectural connection between the different uses with a clear common design theme. Site design, architecture, and signage are intended to be harmonious with the neighborhoods and will conform to the design guidelines found in Section J.

### Open Space (OS) and Park (P)

Open space is a central feature of the Plan Area, and is created to provide a framework for the overall Land Use Plan. The aggregate of approximately thirty-two (32.16) acres of open space (not including parkland) creates an aesthetic view shed between land uses while enhancing alternate circulation opportunities. It provides a means for residents to recreate and relax, to safely and efficiently walk or bike within the community, and it also provides a visual buffer for differing land uses in the community. The overall enhancement to the quality of life is driven by the open space element, which includes open greenbelts and visual corridors, landscape setbacks adjacent to right-of-ways, and open space trail systems.

Although defined separately from Open Space (OS) in the General Plan, Parks are an important part of the open space system of Union Ranch. With approximately thirty-seven (37.29) acres of the Plan Area devoted to recreational open space amenities, (not including private recreational centers), the park component of the Plan will be an integral part of community life at Union Ranch. Public park space in Union Ranch will include recreational amenities such as ball fields, tot lots and play apparatus, benches, picnic areas, shade structures, and landscaping all

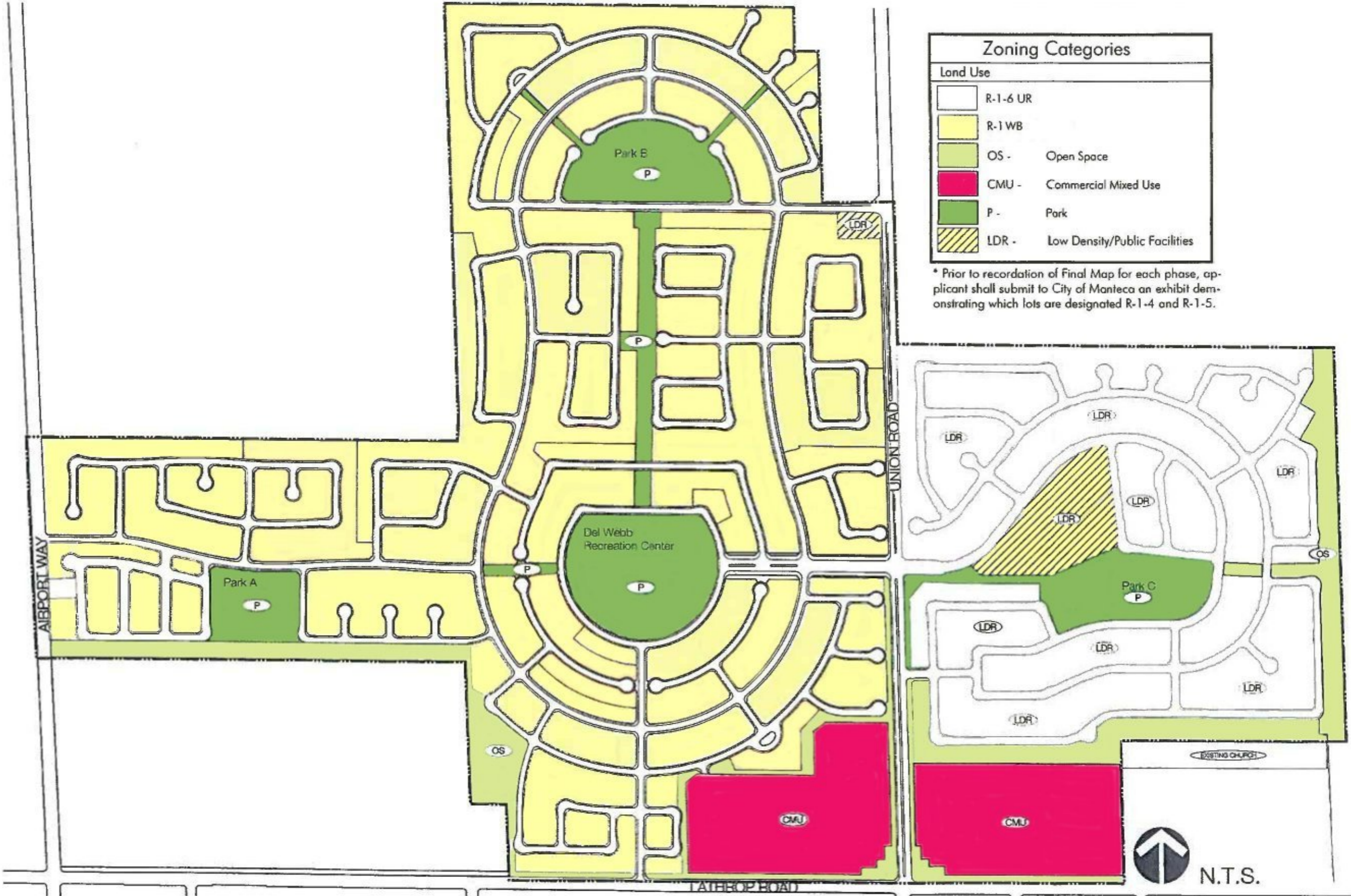

Figure C.1.2 Land Use Zone Map

in conformance to City of Manteca standards. The designated parkland in Union Ranch shall also serve as on-site storm water detention facilities. The function of such shall be integrated into the general park form.

#### Special Purpose Zones, (LDR)-Public Facilities, School Site and Fire Station

A 9-acre elementary school site is proposed to be located within Union Ranch East. It shall be integrated into the center of the development immediately adjacent to a 9.5 acre neighborhood park. A 1.0 acre fire station, to be operated by the Manteca Fire Department shall be located on Union Road, north of the primary community entries.

#### C.4 Permitted Uses and Development Standards

Table C.4.1 provides a detailed allocation of permitted uses in each land use category. Uses are identified with a "C" for conditionally permitted uses and "P" for permitted uses. Uses not identified as either "C" or "P", are not permitted in the Plan Area.

Table C.4.1 Permitted Land Use Summary

GENERAL LAND USE DESIGNATION	LDR	LDR	CMU	OS	P
SPECIFIC PLAN CLASSIFICATION	R-1-6 -UR	R-1-WB			
Residential Use Type					
Apartment			P		
Boarding/Rooming House			C		
Community Care Facility			C		
Condominium Townhouse			C		
Condominium Apartment			C		
Duplex	P	P			
Secondary Residential Unit	P	P			
Senior Citizen Housing Dev.	P	P			
Single-family Detached	P	P			
Agricultural Use Type					
Crops for Use of Resident	P	P			
Recreational/Entertainment and Tourist Facilities Use Type					
Health Club			C		
Park or Playground	P	P	P	P	P
Swimming Pool-private	P	P			
Tennis Court	P	P	P		P
Theater-live			C		

Office Use Type					
Business or Professional			P		
Financial Institution, incl. Bank, S&L, or Credit Union			P		
Real Estate			P		
Temporary On-site Real Estate Tract Sales	C	C	C		
Medical/Dental/Optical			P		
Executive Suites			P		
GENERAL LAND USE DESIGNATION	LDR	LDR	CMU	OS	P
Clerical Support Services			P		
Copy and Graphic Reproduction Services			P		
Retail Sales Use Type					
Antiques			P		
Art Gallery			P		
Bicycle			P		
Bookstore			P		
Christmas Tree- temporary			P		
Clothing and Apparel					
Computer/Communications/ Electronics			P		
Drug Paraphernalia/ Health Supplies			P		
Drugs and Pharmaceuticals			P		
Fabric/Drapery/Upholstery			P		
Floor Covering			P		
Florist			P		
Furniture/ Appliance			P		
Gardening/Landscape Supply			C		
Gift and Card			P		
Gun			P		
Hardware-specialty			C		
Hobbies/Craft Supplies			P		
Home/Office Furnishings			P		
Jewelery/Watches			P		
Lapidary			P		
Lawnmower			C		
Leather Goods/Luggage			P		
Locksmith/Lock-Key Shop			P		
Movie Rental			P		

Music Records/Tapes/CD/DVD			P		
Musical Instruments/Lessons			P		
Office Machines/Equipment			C		
Paint and Wall Paper			P		
Photo. Supply/Camera			P		
Post Office/Packaging/Delivery Service			P		
Pottery/Ceramics/Statuary			P		
GENERAL LAND USE DESIGNATION	LDR	LDR	CMU	OS	P
Shoes			P		
Sporting Goods/Athletic Equipment			P		
Stationary/Office Supply			P		
Swimming Pool Supply/Outdoor Furniture/Outdoor Cooking Equipment			P		
Toys/Hobbies/Gifts			P		
Variety			P		
Food and Beverage Retail Use Type					
Bakery -Small			P		
Brewery-Micro			C		
Catering			C		
Convenience Market			C		
Drive in Food Market/Dairy			C		
Farmers Market			C		
Fruit Stand			P		
Liquor Store			P		
Specialties, incl. Meat/Veg./Health Foods or Candy			P		
Supermarket / Grocery Store			C		
Eating and Drinking Establishments Use Type					
Bar/Tavern or Cocktail Lounge			C		
Ice Cream Parlor			P		
Refreshment Stand/Kiosk			P		
Restaurant—sit down			P		
Restaurant –take out			P		

Services Use Type					
Artists Studio			P		
Automobile Rental			C		
Automobile Services--specialized			C		
Automobile Service Station			C		
Automobile Wash—Full Service			C		
Barber or Beauty Shop			P		
Carpet Cleaning			P		
GENERAL LAND USE DESIGNATION	LDR	LDR	CMU	OS	P
Interior Decorator			P		
Laundromat—Self Service			P		
Laundry/Dry Cleaning/Pressing—Pick Up Only			P		
Pet Grooming			P		
Photography Studio			P		
Picture Framing			P		
Printing/Cartography/Lithography/Blue Printing			P		
Publishing			C		
Shoe Shine Stand			P		
Tailor/Dressmaker			P		
Tanning Salon			P		
Travel Agency			P		
Transportation Use Type					
Multi-modal Transportation Station			P		
Taxi Depot			P		
Information/ Ticket Kiosk			P		
Services Use Type					
Art Gallery—Public/Non Profit			C		
Child Day Care Center			C		
Church			C		
Clinic—Medical/ Physical Therapy			C		
Club/Lodge			C		
Convalescent Hospital			C		
Community Care Facility--Senior			P		
Community or Senior Citizen Center			P		

Fire Station	P		P		
Government Office/ Building			P		
Library			P		
Museum			P		
GENERAL LAND USE DESIGNATION	LDR	LDR	CMU	OS	P
Nursing Home			C		
Post Office			P		
Education Use Type					
College/University Extension			C		
Art/Craft/Music School			P		
Business/Trade School			C		
Dance School			P		
Driving School			P		
Martial Arts School			P		
Photography School			P		
Sound Studio/Radio/TV or Movie			C		
Special Events Sponsored by Organization			C		
Elementary School	P				
Public Utilities-Associated with or accessory to the normal construction of residential subdivisions, public open space, commercial development or high density housing; including but not limited to power poles, water wells, transformers, pumps, back flow devices, lift stations, etc.	P	P	P	P	P
Private Utilites- Communications towers, water tanks, electical substations, etc.	C	C	C	C	C

Table C.4.2 detailed the development standards prescribed by the Specific Plan relative to the land use categories described above. Figures C.4.3 through C.4.12 illustrate examples of lot configurations for the single-family designations. More comprehensive development standards and general guidelines for community design are articulated in more detailed Design Guidelines found in Section J.

Table C.4.2 Development Standards

GENERAL LAND USE DESIGNATION	LDR	LDR	LDR	LDR	CMU	OS	P
SPECIFIC PLAN CLASSIFICATION	R-1-6 -UR (a)	R-1-WB					
Lot Size Categories (b)	N/A	4,600-5,499	5,500-7,499	7,500 +	N/A	N/A	N/A
Minimum Lot Area (sf) (c)	6000	4,600	5,500	7,500	N/A	N/A	N/A
Minimum Lot Width (ft) (c)	60	46	55	75	N/A	N/A	N/A
Minimum Lot Depth (ft) (c)	100	98	98	98	N/A	N/A	N/A
Minimum Front Yard Setback from back of sidewalk to Garage Door (ft)	N/A	20	20	20	N/A	N/A	N/A
Minimum Front Yard Setback to Dwelling (ft) from Property Line	20	20	20	20	N/A	N/A	N/A
Minimum Side Yard Setback-One Side (ft)	5/12	5	5	5	N/A	N/A	N/A
Minimum Rear Yard Setback (ft) (d)	20	13	13	13	N/A	N/A	N/A
Maximum Lot Coverage (% of Lot) Single Story	45%	55%	55%	55%	N/A	N/A	N/A
Maximum Lot Coverage (% of Lot) Two Story	40%	N/A	N/A	N/A	N/A	N/A	N/A
Floor Ratio	N/A	N/A	N/A	N/A	1.0	N/A	N/A
Maximum Building Height	2 stories / 30 feet	1 story/ 20 feet	1 story/ 20 feet	1 story / 20 feet	3 stories / 35 feet	N/A	N/A
Maximum Building Height Adjacent to LDR (ft)	N/A	N/A	N/A	N/A	2 stories /28 feet within 60 feet	N/A	N/A
Minimum Rear Yard Setback from CMU to LDR (ft)	20	N/A	N/A	N/A	20	N/A	N/A

(a) City of Manteca Zone Requirements

(b) In the Woodbridge Section of the URSP the developer is required to provide a percentage of each type of lot category based on lot size as outlined in Table C.3.2 Lot Summary.

(c) In the Woodbridge Section of the URSP minimum lot size for cul-de-sac lots shall be 29' frontage and 80' depth. The Community Development Director may make exceptions for up to 10% of the lots allowing a variance of lot width, depth, area and the 3:1 lot width depth ratio.

(d) 13' minimum setback to livable structure, 8' minimum setback to porch/covered patio in Woodbridge.

4,600 sq. ft. Lot

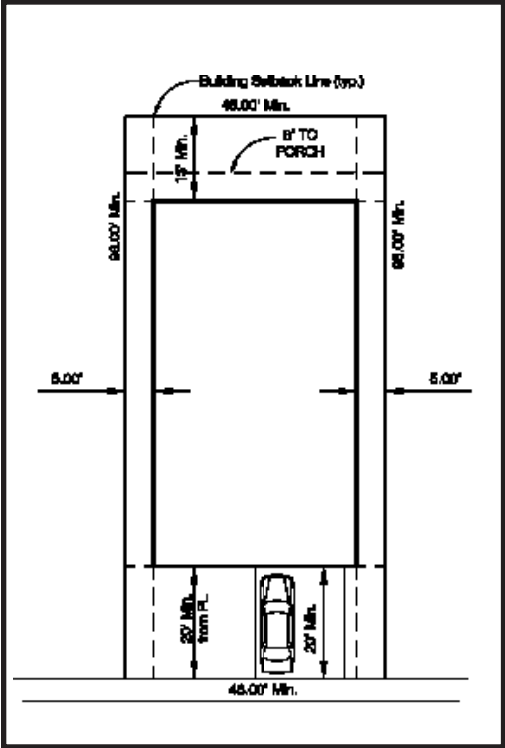

Figure C.4.3 46X98 Foot Lot

4,600 sq. ft. Corner Lot

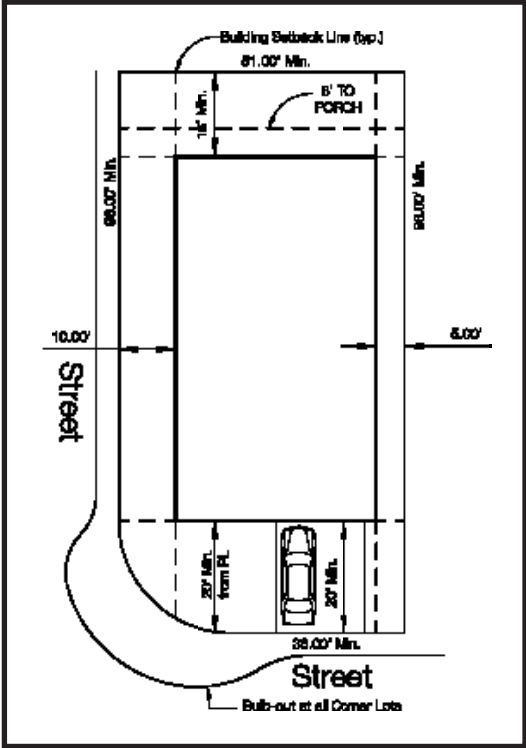

Figure C.4.4 51X98 Foot Corner Lot

5,500 sq. ft. Lot

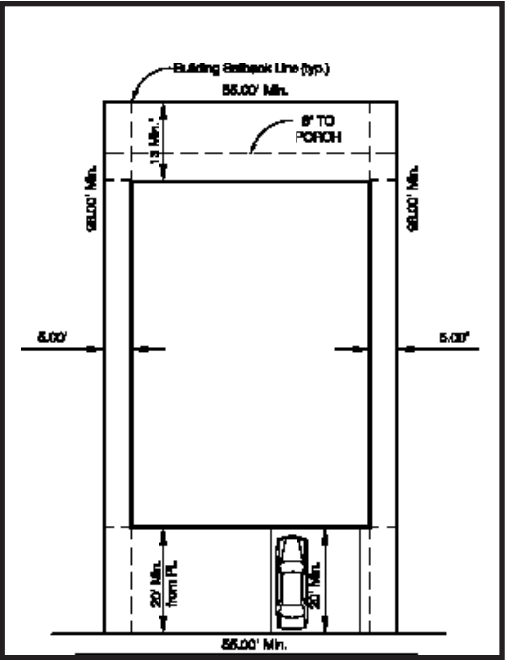

Figure C.4.5 55X98 Foot Lot

5,500 sq. ft. Corner Lot

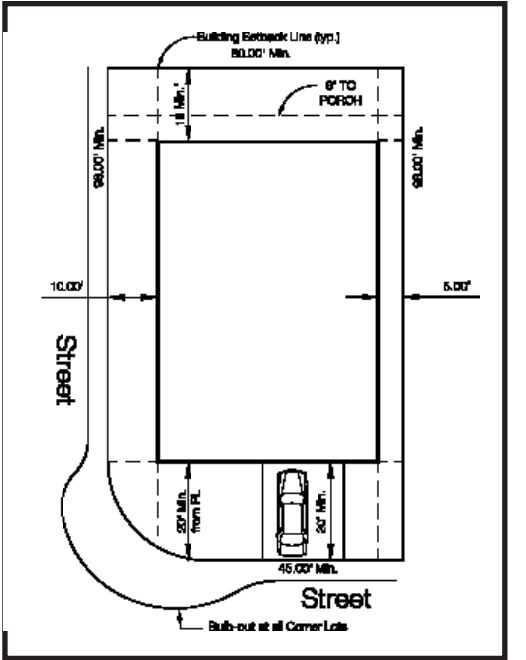

Figure C.4.6 60X98 Foot Corner Lot

7,500 sq. ft. Lot

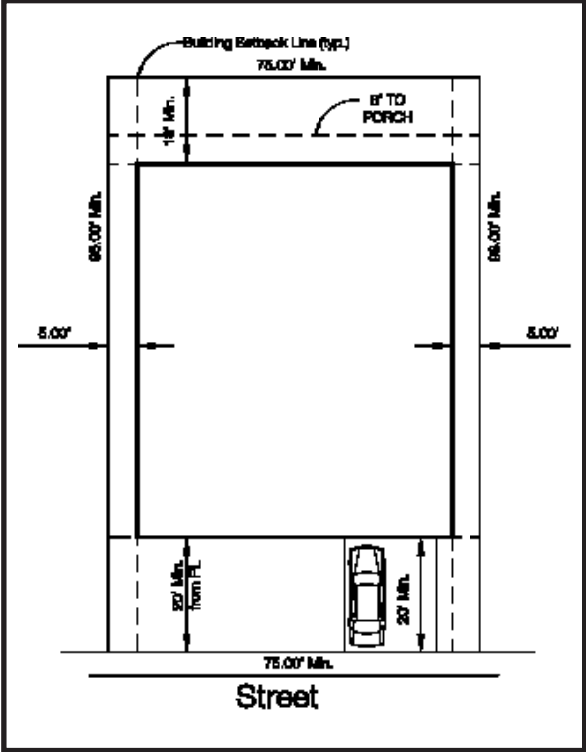

Figure C.4.7 75X98 Foot Lot

7,500 sq. ft. + Corner Lot

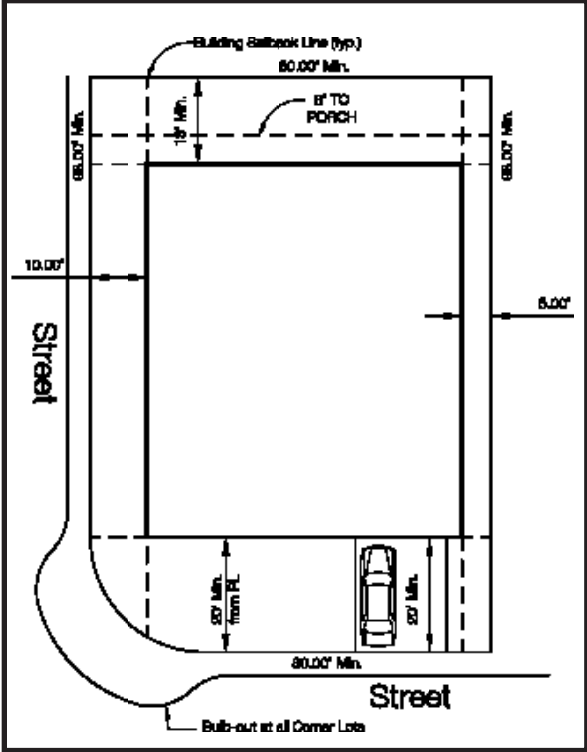

Figure C.4.8 80X98 Foot Corner Lot

This Page Intentionally Left Blank

---

### C.5 Housing Element

Homes located in the Planning Area shall be market based in their design and size, all in compliance with the Specific Plan classifications prescribed in the preceding table. The homes shall be designed and constructed in consideration of the statewide residential new construction energy efficiency program known as California Energy Star New Home Program, created by Pacific Gas & Electric and other allied energy companies. The goal of the program is to exceed energy efficiency in new home construction as required by the California Code of Regulations Title 24, California Building Code Part 6—by reducing energy requirements by a minimum of 15% of Title 24 requirements.

Woodbridge by Del Webb in Manteca is planned to offer 9 single-story homes, with three standard elevations, each specifically designed to meet the needs of today's active adults, age 55 and older. The plans range in square feet from approximately 1300 square feet to approximately 2600 square feet. Specific energy efficient components include, but are not limited to the following:

- Inspection of program ventilation and safety requirements, including fresh-air ventilation, CO detectors, and no unsealed furnaces/water heaters
- Inspection of thermal and air barriers
- Energy Star label
- 5-Star Home rating
- At least 30% more efficient than homes built to the 1993 MEC
- HERS Rating
- Blower door testing
- Reduced carbon emissions exhausted into the atmosphere as compared to standard homes
- Inspection of mechanical sizing/thermal components
- Visual inspection of duct insulation
- Testing for air tightness/pressure balancing

### C.6 General Plan Consistency

The Union Ranch Specific Plan has been prepared to be consistent with the City of Manteca's 2023 General Plan relative to land use. In reviewing this consistency this subsection addresses the policy elements of Community Design, Housing, Circulation, Air Quality, and Open Space and Conservation. For each relevant element the governing policy from the General Plan is provided followed by the supporting descriptive response outlining the Specific Plan's conformance to the General Plan's desired goals for appropriate land use. If the General Plan element has not been addressed then the goal of the elements is not applicable or relevant to the Specific Planning Area, and therefore it has been omitted.

---

## C.6.1 Community Design

### CD-P-1

*Retain the existing central city core as the geographical center of the city.*

Consistency: The Union Ranch Specific Plan enhances the central city core by not allowing conflicting land uses in the Plan to that which is provided in the Central City. In addition, the Plan encourages bicycle, pedestrian, and automobile access to the Central City. This is accomplished by linkage to the Tidewater open space corridor and respecting two existing major arterials in the Plan Area.

### CD-P-7

*The City shall implement neighborhood design standards in the Residential districts that contribute to the overall character of the neighborhood by emphasizing residential features that enhance the sense of community, ensure a safe pedestrian orientation, and minimize the visual prominence of garages.*

Consistency: The Union Ranch Specific Plan provides design guidelines that will ensure a unique and distinctive character for the neighborhoods in the Plan Area. A design emphasis has been placed on the idea of a safe pedestrian environment and a strong sense of community centered on residential neighborhood amenities such as parks, recreation centers, and school sites. Enhanced architectural detailing is encouraged with articulated garage doors complete with raised panels and lights. Other architectural detailing includes the use of brick and stone veneer, cedar shake and horizontal siding, as well as panelled entry doors and shutters on the windows on the primary facade.

### CD-P-10

*Establish city gateway features at intersection of Lathrop Road/Highway 99, Austin Road/Highway 99, McKinley Road/Highway 120.*

Consistency: Not applicable to the Union Ranch Specific Plan, however, the enhanced landscape environment required by the Specific Plan will complement the City gateway proposed at Lathrop Road/Highway 99.

### CD-P-12

*Limit uses that require Soundwalls adjacent to the highways.*

Consistency: Not applicable to the specific area of the Union Ranch Specific Plan because the planning area is not adjacent to either Highway 99 or Highway 120. However, soundwalls are proposed adjacent to major arterials, and residential collectors in the Plan Area.

### CD-P-15

*Major arterial streets shall include a common landscape theme that includes primary street trees, groundcover, sidewalks, bus shelters where required and lighting applied through out the city.*

---

Consistency: The major arterial streets of the Union Ranch Plan, Lathrop, Airport Way and Union, offer a common landscape theme, which identifies and enhances the current standards on both right-of-ways. Enhanced right-of-way setbacks are provided which include primary street trees, sidewalks, enhanced lighting, and groundcover materials.

CD-P-16

*The City shall develop special design standards for the perimeter road system comprising Lathrop Road, Austin Road, Woodward Avenue, and Airport Way to ensure their development as divided roadways.*

Consistency: Section D, Circulation of the Union Ranch Specific Plan illustrates proposed improved right-of-ways on Lathrop Road and Airport Way. Medians are proposed to ensure the development of the sections as divided roads.

CD-P-21

*Provide parks and schools as distinct centers for neighborhoods.*

Consistency: The Union Ranch Specific Plan proposes a series of parks and connecting open space areas as the primary organizing element of the overall community design. Two neighborhood serving parks are to be located in Woodbridge, as well as a centrally located private recreation center. A nine acre school site immediately adjacent to a neighborhood park is to be located in the center of Union Ranch East. The combination park and school site shall be located on a multiuse trail system linking Union Road to the Tidewater Trail.

CD-P-22

*Provide features that distinguish one neighborhood from another, such as natural features, entry gateways, street lighting or signage.*

Consistency: The overall character of Union Ranch as identified in the Design Guidelines ensures a required uniqueness to Woodbridge and Union Ranch East, with enhanced entries using extensive plant palettes, stone veneers, sign walls, arbors and enhanced paving. For more information refer to the Design Guidelines contained in this document.

CD-P-23

*Provide pedestrian systems that connect the center of adjacent neighborhoods.*

Consistency: The Specific Plan offers a strong pedestrian circulation system throughout the Plan Area with a major trail system designed to traverse both east-west and north-south.

CD-P-24

*The City shall ensure through design guidelines that the walls surrounding residential area neighborhoods are attractive and well designed.*

Consistency: Design Guidelines illustrating the selection of built materials such as wall, arbors, fencing, lighting and paving has been identified in the Design Guideline section of this document.

CD-P-25

*The City shall encourage mixed land uses but provide physical separation of design buffers between incompatible land uses.*

Consistency: The CMU portion of the Planning Area shall be integrated into the overall community design with design guidelines that foster the overall character of the community. Direct access will be provided for pedestrians, bicyclists and automobiles. However, a visual and physical separation will be provided by a landscape corridor separating different land use designations.

CD-P-26

*Residential neighborhoods shall be designed to provide access from the neighborhood streets to these open space corridors.*

Consistency: Each neighborhood in the Union Ranch Planning Area shall be linked via a multi-use trail system to all major roadways, open spaces and public parks.

CD-P-30

*Neighborhoods in new growth areas shall incorporate the following characteristics:*

- The edges of the neighborhood shall be identifiable by use of landscaped areas along major streets of natural features, such as permanent open space. Primary arterial streets may be used to define the boundaries of neighborhoods. The street system shall be designed to discourage high volume and high speed traffic through the neighborhood.
- Neighborhoods shall be no more than one mile in length or width.
- Each neighborhood shall include a distinct center, such as an elementary school, neighborhood park(s), and/or mixed-use commercial area within a reasonable walking distance of the homes, approximately one-half mile.
- Each neighborhood shall include an extensive pedestrian and bikeway system comprised of sidewalks and bike lanes along streets and dedicated trails.

Consistency: The Union Ranch Specific Plan is supportive of this goal and has provided major permanent open space areas, trail systems, extensively landscaped corridors, neighborhoods compact in scale and very walkable, focused park centers to each neighborhood, and an extensive network of bike trails and multi-use paths.

CD-P-31

*The pedestrian and bikeway system shall be linked to other pedestrian and bikeways in adjacent neighborhoods and, ultimately, to the Citywide Pedestrian and Bikeway Trail System to provide a continuous interconnected system.*

Consistency: The Union Ranch Planning Area contains a network of bikeways and multi-use trails that cross the area in an east-west direction, as well as connect the Planning Area in a north-south fashion via the Tidewater Trail which ultimately connects to the CBD.

CD-P-32

*New buildings shall be designed to be responsive to the local climate in a manner that provides shelter from sun and rain for pedestrians.*

Consistency: New buildings in the Commercial Mixed Use area are required to provide covered walkways in front of store facades to provide a continuous cover from the elements, from store front to store front within any block or strip of building.

## CD-P-33

*Passive solar design features are encouraged whenever possible. Design of buildings should consider energy-efficient concepts such as natural heating and/or cooling, sun and wind exposure and orientation, and other solar energy opportunities*

Consistency: New buildings in the Commercial Mixed Use area and the private recreation center are encouraged to consider energy efficient concepts, specifically utilizing solar energy opportunities. Refer to section C.5 for a description of energy efficient principles that are proposed for the residential housing component of the Plan.

## CD-P-34

*Solar collectors, if used, shall be oriented away from public view or designed as an integral element of the roof structure.*

Consistency: Solar collectors are required to be oriented away from public view in the Specific Plan.

## CD-P-35

*Architectural elements that contribute to a building's character, aid in climate control and enhance pedestrian scale are encouraged. Examples include canopies, roof overhangs, projections or recessions of stories, balconies, reveals, and awnings.*

Consistency: An Architectural themed character that addresses pedestrian scale and a Specific Plan character is addressed in the Design Guidelines.

## CS-P-36

*Encourage the creation of an urban forest comprised of street trees, residential lot trees, trees in non-residential parking lots and in public open space.*

Consistency: The Union Ranch Specific Plan strongly enhances this policy by enhanced requirements for landscape improvements as outlined in the Design Guideline section of the Plan.

## CD-P-37

*Commercial centers should provide for convenient, attractive pedestrian access from street fronts and from adjacent commercial, office, and residential land uses.*

Consistency: The CMU designated portion of the Plan Area is directly accessed via sidewalks, dedicated bike lanes and roadway. Direct access to Woodbridge is provided for the use of electric vehicles.

## CS-P-38

*Commercial centers should provide for convenient, attractive pedestrian access within the center with dedicated pedestrian ways between all building and pedestrian spaces such as plazas, courtyards and terraces at natural gathering areas within the site.*

Consistency: The Specific Plan addresses pedestrian linkages in the Commercial Mixed Use area as well as throughout the Plan Area as established by the CMU designation in the 2023 General Plan, and further detailed in Section J, Design Guidelines.

## CS-P-38

*Commercial centers should provide for convenient, attractive pedestrian access within the center with dedicated pedestrian ways between all buildings and pedestrian spaces such as plazas, courtyards and terraces at natural gathering areas within the site.*

Consistency: Pedestrian corridors are required in the Plan Area as established by the CMU designation in the 2023 General Plan, and further detailed in Section J, Design Guidelines.

## CS-P-39

*Integrating the pedestrian elements (walkways, plazas and terraces) with the buildings will enhance the pedestrian experience. The pedestrian relationship to building should be comfortable, convenient, and protected from extremes of sun and wind.*

Consistency: Pedestrian plazas and terraces are strongly encouraged/required in the Commercial Mixed Use area and the private recreation center as established by the CMU designation in the 2023 General Plan, and further detailed in Section J, Design Guidelines.

## CD-P-40

*Outdoor plazas or other common areas that provide space for special landscaping, public art, food service, outdoor retail sales or seating areas for patrons are encouraged in retail settings appropriate to such pedestrian activity. The plaza or other common area shall be appropriately scaled to the retail use and shall be directly connected to the primary walkway.*

Consistency: Special plaza terrace areas have been identified in the Specific Plan, which are interwoven into the pedestrian circulation system as established by the CMU designation in the 2023 General Plan, and further detailed in Section J, Design Guidelines.

## CD-P-41

*Buildings adjoining public spaces, including pedestrian ways shall be designed to allow the sun to reach sidewalks and plazas in the winter.*

Consistency: Solar considerations for sun exposure in the winter and shade in the summer are encouraged in the Commercial Mixed Use area as detailed in Section J, Design Guidelines.

## CD-P-42

*Building configurations that provide "outdoor rooms", courtyards, paseos and promenades are encouraged.*

Consistency: The overall architectural character of the Specific Plan encourages and supports this policy as detailed in Section J, Design Guidelines.

## CD-P-43

*Where practical, and in compliance with ADA standards, common areas that provide seating should be separated from the primary walkway by informal barriers, such as planters, bollards, fountains, low fences and/or changes in elevation.*

Consistency: Plazas are enhanced to give special identity and separation from high traffic areas. All built feature shall be ADA compliant.

---

CD-P-44

*Provide minimal levels of street, parking, building, site and public area lighting to meet safety standards and provide direction.*

Consistency: An enhanced lighting program is provided in the Specific Plan. Special attention to pedestrian scale and safety is addressed. Refer to the Design Guidelines in Section J, for more information.

CD-P-45

*Provide directional shielding for all exterior lighting to minimize the annoyance of direct or indirect glare.*

Consistency: This goal is supported in the Design Guideline section of the Specific Plan.

CD-P-46

*Provide automatic shutoff or motion sensors for lighting features in newly developed areas.*

Consistency: This goal is supported in the Design Guideline section of the Specific Plan.

CD-P-47

*The City shall adopt light and glare standards that minimize the creation of new light source and annoyance of direct and indirect glare.*

Consistency: This goal is supported in the Design Guideline section of the Specific Plan.

CD-P-48

*Allow pockets of agricultural activity to remain within the urban areas of the city where such uses are compatible with the surrounding urban use.*

Consistency: The Union Ranch Specific Plan Area is planned to be phased over a period of years. Current agricultural activity will be allowed to remain as the Plan is incrementally developed.

CD-P-49

*Allow use of small under-utilized parcels or undeveloped portions of parcels for temporary, seasonal agricultural activity, such as truck farms, strawberries, and small orchards.*

Consistency: Not applicable because there are no small planned parcels in the Plan Area.

CD-P-50

*In order to retain a visual reminder of the agricultural heritage, the City will permit the use of non-fruiting species, such as flowering cherry and plum, as secondary accent trees in landscape corridors along major streets. The primary street tree shall provide a shade canopy over the street.*

Consistency: The Design Guideline section of the Specific Plan outlines the use of ornamental flowering and non-fruiting tree species as an accent tree. The primary street tree shall provide a shade tree canopy.

## C.6.2 Housing Element - General Plan Consistency

H-P-10

*The City shall encourage mixed use development opportunities, residential development in mixed-use neighborhoods, development that combines residential with service commercial and office uses, and the construction of second units (granny flats, carriage houses and similar small dwelling intended for one or two residents) in appropriate zoning designations.*

Consistency: The CMU designated land use in the Plan Area encourages the use of higher density housing as a component along with other uses such as commercial endeavors and office uses.

H-P-11

*The Commercial Mixed Use (CMU) zone designation shall allow residential use. Commercial Mixed Use (CMU) zones with in infill areas may develop completely with High Density Residential (HDR) land use.*

Consistency: The CMU designated land use in the Plan Area encourages the use of higher density housing as a component along with other uses such as commercial endeavors and office uses.

H-P-25

*In accordance with residential development standards of the State Government Code Sections 65583(c)(1) for factory built housing, the City shall allow mobile home and factory-built housing on a permanent foundation that meets all zoning requirements on any residentially-zoned parcel.*

Consistency: The Specific Plan does not support the construction of mobile homes on permanent foundations in the Plan Area.

H-P-38

*The City will maintain an adequate level of public services and infrastructure to meet the needs of existing and projected development, within the fiscal capacity of the City.*

Consistency: The Plan is supportive of the Housing Element policy.

H-P-39

*The City shall ensure within fiscal limitations that park and recreation facility acquisitions and improvements keep pace with residential development.*

Consistency: The Plan is supportive of the Housing Element policy.

H-P-40

*The City shall ensure that housing developments pay their own way in terms of financing public facilities and services.*

Consistency: The Plan is supportive of the Housing Element policy.

H-P-42

*The City shall encourage the development of new housing units designed for the elderly and disabled persons to be in close proximity to public transportation and community services.*

Consistency: The Plan is supportive of the Housing Element policy by providing senior or active adult housing immediately adjacent to commercial mixed-use development, which is located on major arterial corridors.

H-P-45

*The City shall prohibit discrimination in the sale or rental of housing with regard to race, ethnic background, religion, handicap, income, sex, age, and household composition.*

Consistency: The Plan is supportive of the Housing Element policy.

H-P-47

*The City shall give special attention in housing programs to the needs of special groups, including the disabled, large families, the elderly, and families with lower incomes.*

Consistency: The Plan is supportive of the Housing Element policy by focusing on the provision of housing for seniors.

H-P-49

*The City shall promote the use of energy conservation features in the design of all new residential structures.*

Consistency: The Plan is supportive of the Housing Element policy by requiring that new home construction meet or exceed the current energy star rating system.

H-P-50

*The City shall encourage residential construction of durable materials and designs suited to the local conditions that will contribute to reductions of the life-cycle cost of the dwelling.*

Consistency: The Design Guideline section of the Plan outlines the minimum requirements for the design of new residential units and encourages the use of durable materials and innovative construction techniques to assist to reduce the life-cycle cost of the dwelling while providing a superior housing product.

H-P-51

*The City shall encourage innovative building construction techniques and materials to reduce initial and ongoing housing costs and provide superior housing.*

Consistency: The Design Guideline section of the Plan outlines the minimum requirements for the design of new residential units and encourages the use of durable materials and innovative construction techniques to assist to reduce the life-cycle cost of the dwelling while providing a superior housing product

H-P-53

*The City shall encourage land use and circulation development patterns that facilitate the use of lower cost alternative vehicles.*

Consistency: The Plan is supportive of the Housing Element policy by providing a multi-use path system that would allow small electric vehicles to operate in the Woodbridge portion of the Plan Area, with parking spaces available at the recreation center in Woodbridge. Vehicles shall be allowed on streets where speeds are posted at less than 35 mph, unless specified otherwise by the City of Manteca. Public access via sidewalk and multi-use trail is proposed between the CMU parcels along Lathrop road and the internal street system of Woodbridge.

### C.6.3 Circulation Element

#### C.6.3a Street System

##### C-P-1

*The City shall strive to attain the highest possible traffic levels of service (LOS) consistent with the financial resources available and the limits of technical feasibility. The impact of new development and land use proposal on*

*LOS should be considered in the review process.*

Consistency: The Plan is supportive of the Circulation Element policy, for more information refer to the traffic study found as a supplement to the EIR for Union Ranch.

##### C-P-2

*Manteca's target for transportation LOS is to provide City-wide average LOS of C or better, and a minimum of LOS D at any individual location. LOS C, LOS D and the other Level of Service ratings as defined in current traffic engineering standards. This "C average, D minimum" shall be accomplished by attempting to provide LOS C at all locations, but accepting LOS D under the following circumstances:*

- a. *Where construction facilities with enough capacity to provide LOS C is found to be unreasonably expensive. This applies to facilities, for example on which it would cost significantly more per dwelling unit equivalent (DUE) to provide LOS C than to provide LOS D.*
- b. *Where it is difficult or impossible to maintain LOS C because surrounding facilities in other jurisdictions operate at LOS D or worse.*
- c. *Where free-flowing roadways or interchange ramps would discourage use of alternate travel modes.*
- d. *Where maintaining LOS C will be a disincentive to use of existing alternative modes or to the implementation of new transportation modes that would reduce vehicle travel.*

Consistency: The Plan is supportive of the Circulation Element policy, for more information refer to the supplemental traffic study contained in the EIR.

##### C-P-3

*Streets shall be dedicated, widened, extended, and constructed according to the Street cross-section diagrams established in the City Improvement Standards. Dedication and improvement of full rights-of-ways as shown in the Street Standards shall not be required in existing developed areas where the City determines that such improvements are either infeasible or undesirable.*

---

Consistency: The Plan calls for all streets to be dedicated, widened, and constructed at a minimum to the current City Standards shown as detailed in Section D. Circulation.

C-P-4

*Major circulation improvements shall be completed as abutting lands develop or re-develop, with dedication of right-of-way and construction of improvements, or participation in construction of such improvements, required as a condition of approval.*

Consistency: The Specific Plan is supportive of this element. Refer to Section D. Circulation for proposed roadway improvements in the Plan Area.

C-P-5

*Development which would necessitate roadway improvements prior to the development of lands abutting those roadway improvements shall be required to make such improvements, or participate in such improvements, as a condition of approval.*

Consistency: The Specific Plan is supportive of this element. Refer to Section D. Circulation for proposed roadway improvements in the Plan Area.

C-P-6

*New development will pay a fair share of the costs of street and other traffic and transportation improvements based on traffic generation and impacts on levels of service in conformance with the standards and policies established in the Public Facilities Implementation Plan.*

Consistency: As part of the implementation of the Specific Plan transport PFIP fees shall be paid, as well improvements made to existing arterial roads within the Plan Area.

C-P-7

*The street system shall be expanded in a contiguous and concentric manner to serve new development areas and provide improved circulation for existing residents.*

Consistency: The Specific Plan is supportive of this element. Refer to Section D. Circulation for proposed roadway improvements in the Plan Area.

C-P-8

*Street improvements will be designed to provide multiple, direct and convenient traffic routes.*

Consistency: The Specific Plan is supportive of this element. Refer to Section D. Circulation for proposed roadway improvements in the Plan Area.

C-P-9

*Residential and collector street intersections with collector and arterial streets shall be aligned with other residential and collector streets, where feasible, to allow light electric vehicles (NEVs), bicyclists, and pedestrians to travel conveniently and safely from one neighborhood to another without using major streets.*

Consistency: The Specific Plan is supportive of this element. Refer to Section D. Circulation for proposed roadway improvements in the Plan Area, as well as the supplemental Circulation Study prepared by kdAnderson Transportation Engineers.

## C-P-10

*Signals, roundabouts, traffic circles and other traffic management techniques shall be applied at residential and collector street intersections with collector and arterial streets in order to allow light electric vehicles (NEVs), bicyclists, and pedestrians to travel conveniently and safely from one neighborhood to another.*

Consistency: The Specific Plan is supportive of this element. Refer to Section D. Circulation for proposed roadway improvements in the Plan Area, as well as the supplemental Circulation Study prepared by kdAnderson Transportation Engineers.

## C-P-11

*Major circulation improvements which are not tied to abutting development, such as new freeway interchanges or additional freeway ramps, should be implemented ahead of, or at the same time as, major new development within the city which would otherwise result in serious traffic impacts for some or all of the remaining circulation system.*

Consistency: The circulation study prepared by kdAnderson Transportation Engineers, and included in the appendix to the Specific Plan states that no serious impacts are expected from the implementation of the Plan. For more information refer to the study.

## C-P-12

*The City shall promote development of a perimeter road system along Lathrop Road, Austin Road, Woodward Road, and Airport Way.*

Consistency: The Plan is supportive of the Circulation Element policy by proposing improvements to Lathrop Road and Airport Way.

## C-P-13

*The City may allow the development of private streets in new residential projects that demonstrate the ability to facilitate police patrol, emergency access, and solid waste collection and fund on-going maintenance to the satisfaction of the Community Development Director.*

Consistency: There are no private streets planned as a part of the Specific Plan.

## C-P-14

*The City shall promote infill development that completes gaps in the circulation system to facilitate north-south and east-west circulation.*

Consistency: The Specific Plan provides for improved road systems with the widening and improving of Union Road and Airport Way in a north/south direction, and Lathrop Road in an east/west direction.

## C-P-15

*Residential subdivisions with lots fronting on an existing freeway or arterial street shall provide for a separate frontage road. Developers shall build frontage roads per City Improvement Standards.*

Consistency: Not applicable to the Union Ranch Plan Area as no lots are proposed to front an arterial street or freeway.

## C-P-16

*All residential developments along the south side of the SR 120 By-pass shall be developed with a frontage road between the residential development and the freeway and provided with acceptable noise attenuation measures.*

Consistency: Not applicable to the Union Ranch Plan Area as it is not located south of Route 120 By-pass.

## C-P-17

*Residential subdivisions backing onto a freeway are discouraged. Where subdivisions back on to an arterial or collector, the developer shall have the option to build a masonry wall or a combination wall and berm. The top of walls along freeways shall be at least eight-feet above the elevation of the freeway travel lanes. Walls and berms shall be attractive and developed for low maintenance. All such berms and walls shall be approved by the City.*

Consistency: Residential Lots backing on to arterial or collector streets will have soundwalls located along the rear property lines. Refer to Section J, Design Guidelines for more information.

## C.6.3b Traffic Safety

## C-P-21

*The creation or continuance of traffic hazards shall be discouraged in new development and other proposals requiring the City to exercise its discretionary authority.*

Consistency: The Plan will be designed to meet or exceed all current or future standards of the City of Manteca and minimize traffic hazards.

## C-P-22

*In the development of new projects, the City shall give special attention to maintaining adequate corner-sight distances to City street intersections and at intersection of City streets and private access drives and roadways.*

Consistency: The Plan shall meet or exceed all current requirements of site distance clearances of the City of Manteca with no built objects located within view triangles, and all roadways/driveways clear a minimum of 20-feet to curb return.

## C-P-23

*The City shall identify and remove, as feasible, obstacles limiting corner-sight distances at City street corners.*

Consistency: The Plan shall meet or exceed all current requirements of site distance clearances of the City of Manteca with no built objects located within view triangles, and all roadways/driveways clear a minimum of 20-feet to curb return.

## C-P-24

*The City shall maintain a program of identification and surveillance of high traffic accident locations, with emphasis on early detection and correction of conditions, which could potentially constitute traffic hazards.*

---

Consistency: The Plan is designed to all current standards of the City of Manteca.

### C.6.3c Parking

C-P-29

*Ensure that there is adequate parking for normal commercial activities.*

Consistency: All areas with off-street parking will conform to the current City of Manteca Zoning Code.

C-P-30

*Ensure that there is adequate parking for special events.*

Consistency: All areas with off street parking will conform to the current City of Manteca Zoning Code. Special event parking may include on-street parking where allowable, or parking in the private recreational club facilities located in the Del Webb development.

C-P-31

*Coordinate the parking area locations with the roadway, transit, pedestrian, and bikeway systems.*

Consistency: The Plan is designed to maximize on street parking, and to provide for parking in the commercial mixed-use portion of the site. The network of multi-use pedestrian and bike trails will allow access the parking areas.

C-P-32

*Parking lots will be provided in the downtown area to provide small parking areas within easy walking distance of the businesses, rather than single large parking lot.*

Consistency: Not applicable to the Union Ranch Plan Area as it is not located in the downtown area.

### C.6.3d Transportation Alternatives

C-P-33

*The City should establish a safe and convenient network of identified bicycle routes connecting residential areas with recreation, shopping, and employment areas within the City.*

Consistency: The Union Ranch Specific Plan has been designed to enhance a citywide network of safe and convenient bicycle routes and enhance them internally within the Plan Area. An east/west connection is made across the entire Plan Area by means of a multi-use pedestrian and bike path that will connect to the Tidewater Trail.

C-P-34

*Provide spur or branch walkways connecting to the residential neighborhoods and primary public destinations.*

Consistency: The Union Ranch Specific Plan provides a comprehensive network of sidewalks, dedicated bike lanes and multi-use paths that connect new and existing neighborhoods.

---

C-P-35

*Route sidewalks so that they connect to major public parking areas, transit stops, and intersections with the bikeway system.*

Consistency: The Union Ranch Specific Plan provides a comprehensive network of sidewalks, dedicated bike lanes and multi-use paths that connect new and existing neighborhoods.

C-P-36

*Provide adequate bicycle parking facilities at commercial, business/professional and light industrial uses.*

Consistency: Parking facilities shall be required in all the Plan Area to meet or exceed the requirements of the City of Manteca.

C-P-37

*Improve safety conditions, efficiency, and comfort for bicyclists and pedestrians. Provide shade and/or protection from wind and other weather conditions when possible.*

Consistency: Safety conditions have been enhanced for bicycle use with shade trees along bike routes, and the requirement for adequate weatherproof parking facilities at the commercial mixed use development. All bicycle corridors intersect at major right-of-way intersections where easy protected crossings can be made. The Tidewater Bicycle corridor does intersect with Lathrop Road, with signalized crossing available at Union Road.

C-P-38

*Wherever possible, bicycle facilities should be separate from roadways and walkways.*

Consistency: Dedicated on-road bike lanes are provided on certain road sections as detailed in Section D. Circulation. Multi-use paths of minimum 12-foot width are provided in the Plan Area to allow safe usage by both bicyclists and pedestrians.

C-P-39

*The City shall limit on-street bicycle routes to those streets where the available roadway width and traffic volumes permit safe coexistence of bicycle and motor vehicle traffic.*

Consistency: Dedicated on-road bike lanes are provided on certain road sections as detailed in Section D. Circulation, where safe joint usage will allow. Multi-use paths of minimum 12-foot width are provided in the Plan Area to allow safe usage of both bicyclists and pedestrians.

C-P-40

*The City shall develop a "city-loop" Class I bike path that links Austin Road, Atherton Drive, (the proposed new road south of SR 120), Airport Way and a route along or near Lathrop Road to the Tidewater bike path and its extensions.*

Consistency: The Specific Plan proposes a dedicated bike lane along Lathrop Road connecting directly to the Tidewater Trail- Bike Corridor along with a multi-use path through-out the entire Plan Area.

C-P-41

*The City shall extend the bicycle route north along the former Tidewater Southern Railway*

*right-of-way, and any branch or connecting link.*

Consistency: The Specific Plan proposes the construction of the Tidewater Trail north of Lathrop Road to the limits of the Plan Area.

#### C.6.4 Air Quality Element

##### AQ-P-1

*Cooperate with other agencies to develop a consistent and coordinated approach to reduction of air pollution and management of hazardous air pollutants.*

Consistency: The Specific Plan supports the use of electric vehicles in the Del Webb portion to reduce auto emissions. Furthermore, multi-use bike and pedestrian trails are proposed for the Planning Area to assist in reducing hazardous air pollutants.

##### AQ-P-2

*Develop a land use plan that will help to reduce the need for trips and will facilitate the common use of public transportation, walking, bicycles, and alternative fuel vehicles.*

Consistency: The Specific Plan fully supports this policy by reducing the required automobile vehicular trips by the following methods:

- 1) Strong pedestrian circulation system that unifies the Plan Area.
- 2) Provides pedestrian circulation that links to the City- wide trail system. This is accomplished by the extension of the Tidewater Open Space corridor, a new East-West linkage in the heart of the Plan Area, new internal north-south linkages, and enhanced pedestrian corridors on the major arterials.
- 3) All pedestrian corridors accommodate bicyclists as well as pedestrians.

##### AQ-P-3

*Segregate and provide buffers between land uses that typically generate hazardous or obnoxious fumes and residential or other sensitive land uses.*

Consistency: Landscape buffers and soundwalls are provided between arterial right-of-ways and residential uses. No hazardous or obnoxious adjacent land uses exist or are proposed in the 2023 General Plan.

##### AQ-P-4

*Develop and maintain street systems that provide efficient traffic flow and thereby minimize air pollution from automobile emissions.*

Consistency: The Specific Plan street system has been designed to provide efficient traffic flow to the three major arterial right-of-ways, Lathrop, Union and Airport Way, and internally as well.

##### AQ-P-5

*Develop and maintain circulation systems that provide alternatives to the automobile for transportation, including bicycle routes, pedestrian paths, bus transit, and carpooling.*

Consistency: Alternatives to automobile are provided internally and to the external City- wide community, which addresses bicycle and pedestrian opportunities. Pedestrian/Bicycle access

---

to the existing carpool lots on Lathrop are supported in the Plan Area. Bus transit is encouraged in the commercial mixed-use area.

AQ-P-6

*Coordinate public transportation networks, including trains, local bus service, regional bus service and rideshare facilities to provide efficient public transit service.*

Consistency: Not applicable to the Union Ranch Specific Plan planning document.

AQ-P-7

*New construction will be managed to minimize fugitive dust and construction vehicle emissions.*

Consistency: The Plan requires construction to meet all current/future City Building Department/Public Works requirements. Dust shall be controlled as per Section 10 of the State of California Department of Transportation Standards.

AQ-P-8

*Wood burning devices shall meet current standards for controlling particulate air pollution.*

Consistency: No wood burning devices, including stoves or fireplaces shall be allowed in the Planning Area. Natural gas inserts shall be permitted.

AQ-P-9

*Burning of any combustible material within the City will be controlled to minimize particulate air pollution.*

Consistency: The Plan requires construction to meet all current/future City Building Department/Public Works requirements

AQ-P-10

*Encourage energy efficient building designs.*

Consistency: The Plan requires energy efficient building designs that promote solar orientation in the building design, and the use of energy efficient appliances and lighting.

## C.6.5 Resource Conservation Element

### C.6.5a Water Quality

RC-P-1

*The City shall continue to implement water conservation standards for all commercial and industrial development.*

Consistency: The Specific Plan is consistent in its policies to minimize water consumption and to educate residents and commercial/office users in the Plan Area by planting water efficient landscapes that employ controlled irrigation, and plantings of low to moderate water use plants.

RC-P-2

*The city shall explore potential uses of treated wastewater when opportunities become available.*

Consistency: The Plan supports the 2003 General Plan update in encouraging uses of treated wastewater in a City- wide program. Due to the distance from the wastewater treatment plant, this probably is not practical or quantities available for this Plan Area.

RC-P-3

*The city shall protect the quantity of Manteca's groundwater.*

Consistency: Water conservation is promoted in the Specific Plan with surface drainage to recharge overland in parks and open space areas.

RC-P-4

*The City shall require water conservation in both City operations and private development to minimize the need for the development of new water sources.*

Consistency: The Specific Plan is consistent in its policies to minimize water consumption and to educate residents and commercial/office users in the Plan Area by planting water efficient landscapes that employ controlled irrigation, and plantings of low to moderate water use plants.

### C.6.5b Energy Conservation

RC-P-6

*Develop construction and design standards that promote energy conservation.*

Consistency: The Specific Plan promotes construction and design standards that are current to the City wide standards and further encourages energy conservation in its Design Guidelines.

RC-P-7

*Conserve Public Utilities*

Consistency: The efficient use of public utilities is encouraged with sound design of basic infrastructure requirements, all to current City of Manteca standards.

RC-P-8

*Conserve petroleum products*

Consistency: Petroleum products are conserved by the extensive non-vehicular circulation system and the minimizing of turf to limit gas operated lawn mowers.

---

### C.6.5c Soils and Erosion Control

RC-P-10

*Minimize soil erosion and loss of topsoil from land development activities, wind, and water flow.*

Consistency: Construction in the Plan Area shall comply with the State of California General NPDES Permit regulating storm water associated with construction activity from soil disturbances.

### C.6.5d Water Quality

RC-P-11

*Minimize sedimentation and loss of topsoil from soil erosion.*

Consistency: Construction in the Plan Area shall comply with the State of California General NPDES Permit regulating storm water associated with construction activity from soil disturbances.

RC-P-12

*Minimize pollution of waterways and other surface water bodies from urban runoff.*

Consistency: On-site detention facilities and drainage channels for storm water conveyance shall be constructed in the Plan Area. For more information refer to Section F. Infrastructure.

RC-P-13

*Protect the quality of Manteca's groundwater.*

Consistency: Water quality will be protected by providing capture of urban runoff, and limiting uses that can detrimentally affect long term groundwater quality.

RC-P-14

*Encourage participation by the County and surrounding communities in a basin-wide groundwater management study.*

Consistency: Water quality will be protected by providing capture of urban runoff, and limiting uses that can detrimentally affect long term groundwater quality. For more information refer to Section F. Infrastructure.

RC-P-15

*Once sewer service has been extended to incorporate areas, new septic tanks shall not be permitted.*

Consistency: Sanitary connections shall be provided to all new development in the Plan Area. Septic Tanks shall not be allowed.

### C.6.5e Open Space

RC-P-16

*Provide public and private open space within urbanized parts of Manteca, in order to provide visual contrast with the built environment and to provide for the creational needs of residents.*

---

Consistency: The Plan provides seventy (69.45) acres or 13-percent of the total Plan Area with Open Space or Parkland. All have been carefully planned to be in close proximity to all residential units in the Plan Area and visually available from the major arterials.

RC-P-17

*Provide access to public open space areas.*

Consistency: The Plan provides public access both internally and externally to the open space areas of the Plan and the Community through a network of multi-use path systems, sidewalks and roadways.

RC-P-18

*New development shall maximize the potential for open space and visual experiences.*

Consistency: The Plan maximizes the visual experiences by locating open space adjacent to major view corridors. The open space corridors as well provide long vanishing points in the design to enhance viewing experiences. Open space areas maximize their potential by their location and relation to pedestrian corridors, and commercial mixed-use areas.

#### C.6.5f Agricultural Resources

RC-P-19

*The city shall support the continuation of agricultural uses on lands designated for urban use, until urban development is imminent.*

Consistency: Because the Specific Plan is phased, and because the intent of the Plan is to encourage the existing agricultural use to continue, the Union Ranch Specific Plan supports this policy of the Agricultural Resources elements.

RC-P-20

*The city shall provide an orderly and phased development pattern so that farmland is not subjected to premature development pressure.*

Consistency: The phased development of the Plan is outlined in the Specific Plan, refer to Section H, for more information.

RC-P-21

*In approving urban development near existing agricultural lands, the City shall take actions so that such development will not unnecessarily constrain agricultural practices or adversely affect the viability of nearby agricultural operations.*

Consistency: The Land Use Plan has been developed to look inwardly toward existing Manteca urban development and to prevent impact to existing agricultural lands to the north. Access to existing farmlands will be minimized with limited street extension, furthermore, parcels within the Plan Area will be fenced or walled.

RC-P-22

*Nonagricultural uses in areas designated for agriculture should be redirected to urban areas.*

---

Consistency: Not applicable to the Union Ranch Specific Plan because the Planning Area land is a designated urban area.

RC-P-24

*Provide buffers at the interface of urban development and farmland, in order to minimize conflicts between these uses.*

Consistency: The proposed 2023 General Plan sets aside agriculture and very low density residential to the north of the Plan Area to provide a buffer to agricultural lands.

RC-P-25

*The City Shall ensure, in approving urban development near existing agricultural lands, that such development will not unnecessarily constrain agricultural practices or adversely affect the economic viability of nearby agricultural practices or adversely affect the economic viability of nearby agricultural operations.*

Consistency: The Union Ranch Specific Plan does not constrain adjacent agricultural practices or the economic viability of existing agricultural operations.

RC-P-26

*The City shall restrict the fragmentation of agricultural land parcels into small rural residential parcels except in areas designated for estate type development in the General Plan Land Use Diagram.*

Consistency: The Specific Plan does not propose the fragmentation of land parcels into small rural residential parcels.

RC-P-27

*The City shall discourage the cancellation of Williamson Act contracts within the Primary Urban Service Boundary line.*

Consistency: No parcels in the Specific Plan Area are subject to Williamson Act contracts.

RC-P-28

*The City shall not extend water and sewer lines to premature urban development, that would adversely affect agricultural operations.*

Consistency: All proposed extensions are consistent with City utility master plans and there is no premature development in this Plan Area.

### C.6.5g Biological Resources

RC-P-31

*Minimize impact of new development on native vegetation and wildlife.*

Consistency: Most of the Plan Area is existing, or previous agricultural land. The existing native vegetation consists of existing native Oaks in the Commercial Mixed Use area, which will be retained in the Plan if their health is in good condition.

RC-P-32

*Condition new development in the vicinity of the San Joaquin River and Wathall Slough to promote and protect riparian habitat, wetlands, and other native vegetation and wildlife communities and habitats.*

Consistency: Not applicable to the Union Ranch Specific Plan planning document.

RC-P-33

*Discourage the premature removal of orchard trees in advance of development, and discourage the removal of other existing healthy mature trees, both native and introduced.*

Consistency: The Plan will be phased, with existing orchards remaining in production as long as possible. Existing native Oaks will be retained, wherever possible, whenever long-term health viability is present.

RC-P-34

*Protect special-status species and other species that are sensitive to human activities.*

Consistency: No special-status species have been identified in the Specific Plan or the 2023 General Plan process in the Plan Area.

RC-P-35

*Allow contiguous habitat areas.*

Consistency: Existing habitat areas will not be disturbed in the Plan Area, refer to Section G. Resource Management for more information.

C.7 Special Lot Provision

The current City of Manteca Zoning Ordinance prohibits through lots. Due to the unique circumstances of the existing DeGroot home located within the project boundary, a through lot will be permitted in this specific location by the Union Ranch Specific Plan. This layout will encourage access from the DeGroot home via internal residential streets, while not eliminating the property's existing right of access to Airport Way.

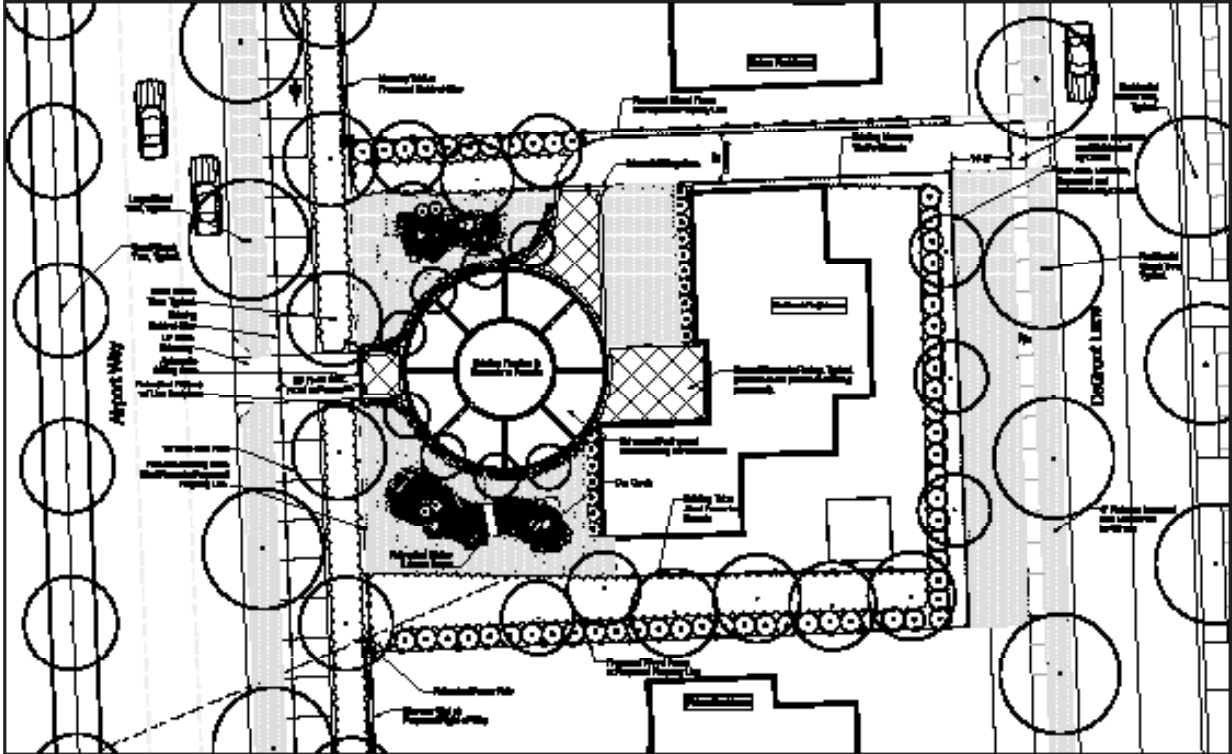

Figure C.7.1 DeGroot Lot

## Section D. Circulation

The circulation system proposed for Union Ranch is comprised of arterial roads, collector streets, neighborhood streets, bikeways and pedestrian paths, a major trail system, and future public transportation routes. The primary goal of the circulation plan is to provide an improved circulation system that allows for the safe and efficient movement of people, goods, and services within the Plan Area and to provide efficient connections to existing systems and routes in the City of Manteca. Other goals, in support of the General Plan and the Draft Residential Design Guidelines, are:

- To expand transportation alternatives within the City, such as bicycling, walking and access to future public transit.
- Minimize traffic accidents and hazards.
- Ensure the adequate provision of both on-street and off-street parking.
- Provide street improvements that meet City standards, and if they do not, to propose a standard that is safe, efficient, and assists to support the character of the community.
- Provide residential streets that are attractive and contribute to the overall sense of community.

Improvements within the Plan Area include the provision of new right-of-ways as well as improvements to existing street sections, with traffic signal(s) added where necessary. The proposed circulation system will provide convenient and safe access to all locations within the Plan Area as illustrated in Figure D.1.1, Circulation Diagram. The Traffic Impact Study per the EIR summarizes the cumulative traffic counts and provides a basis for roadway sizing shown on the Circulation Diagram. It demonstrates that the proposed Circulation Plan is consistent with the General Plan. For additional detail, please refer to the Traffic Study prepared in support of the Specific Plan.

The existing right-of-ways of Lathrop Road, Union Road, and Airport Way form the backbone of the Plan Area and shall be improved as part of this Plan. New right-of-ways are proposed that include City standard sections for residential streets and proposed street sections per the City's draft residential design guidelines. A summary is as follows:

- Arterial Road: Lathrop Road, a portion of Union Road, Airport Way
- Residential Collector: Typical Residential Street, Union Ranch East. Typical Residential Street, Woodbridge by Del Webb
- Neighborhood Street: Typical Residential Street, Union Ranch East
- Major Residential Collector: Woodbridge by Del Webb primary entrance road
- Residential Collector: Woodbridge by Del Webb secondary entrance road
- Neighborhood Street: Woodbridge by Del Webb, typical neighborhood street
- Neighborhood Street: Woodbridge by Del Webb, typical cul-de-sac street
- Neighborhood Street: Woodbridge by Del Webb, typical neighborhood street at parkway

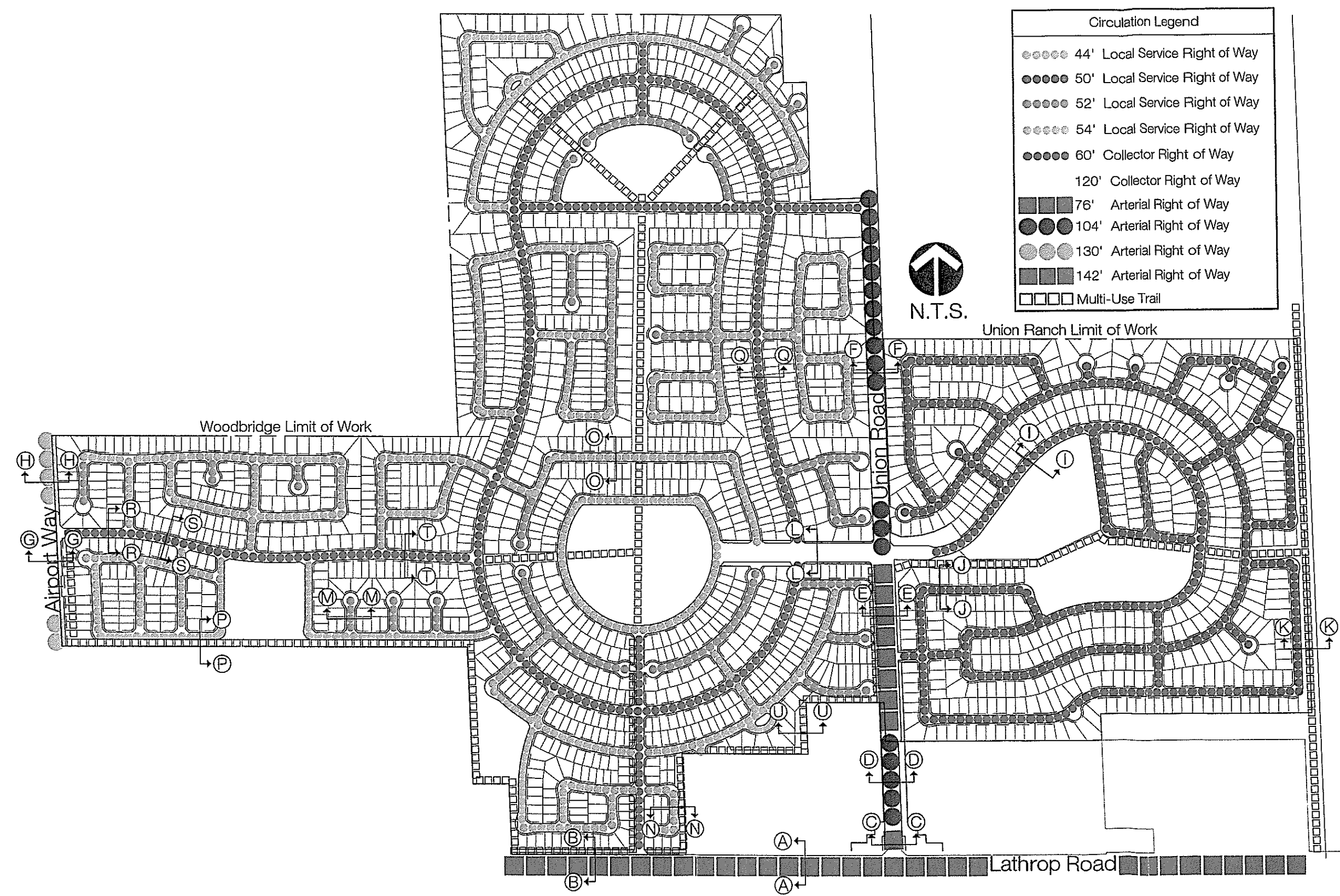

Figure D.1.1 Circulation Diagram

## D.1 Existing Right-of-Ways

Four major existing right-of-ways shall be employed in the Plan Area and they are Lathrop Road, Union Road, Airport Way, and the Tidewater Trail. As existing right-of-ways they help define the periphery of the Plan Area and form the basic north-south and east-west traffic corridors. Each shall be improved to exceed current City of Manteca standards.

Union Road is a major existing north-south right-of-way extending from south of Highway 120 to French Camp. Existing infrastructure on Union Road includes extensive community facilities, such as a High School, City Offices, and commercial facilities. Lathrop Road is a major existing east-west right-of-way extending from east of Highway 99 to Interstate 5. The Tidewater Open Space Corridor is the former right-of-way for the Tidewater Railroad that has been reclaimed by the City of Manteca as a pedestrian bicycle corridor, and shall be continued north of Lathrop Road, on the eastern edge of the Plan Area. Airport Way is an existing arterial road, with minimum improvements. Existing right-of-ways will be improved to the following standards:

### Lathrop Road

Lathrop Road shall be widened to its full right-of-way width per the City's General Plan and shall include 20-foot landscape lot fronting the proposed commercial mixed-use development. A general description of the typical road section is as follows:

- The provision of four travel lanes with a 12-foot center median
- 5-foot Class II designated bike lane, single side of the right-of-way
- Vertical curb and gutter, typical
- 6-foot +/- parkway strip-improved on the north side of the road only
- 5-foot sidewalk

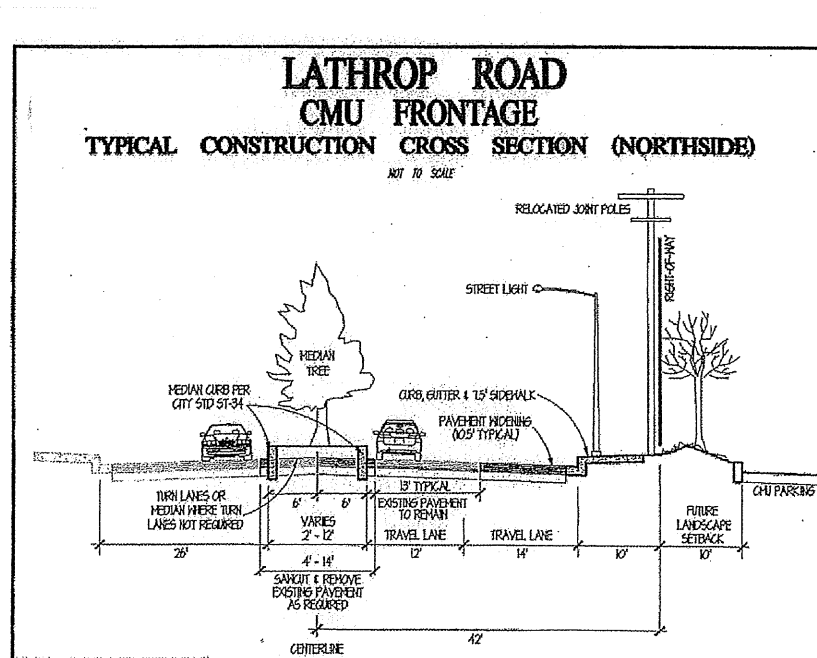

Lathrop Road Trail Frontage

- The provision of four travel lanes with a 12-foot center median
- Vertical curb and gutter, typical
- 10-foot parkway strip-improved on the north side of the road only
- 12-foot Multi-use path
- 8-foot landscape easement

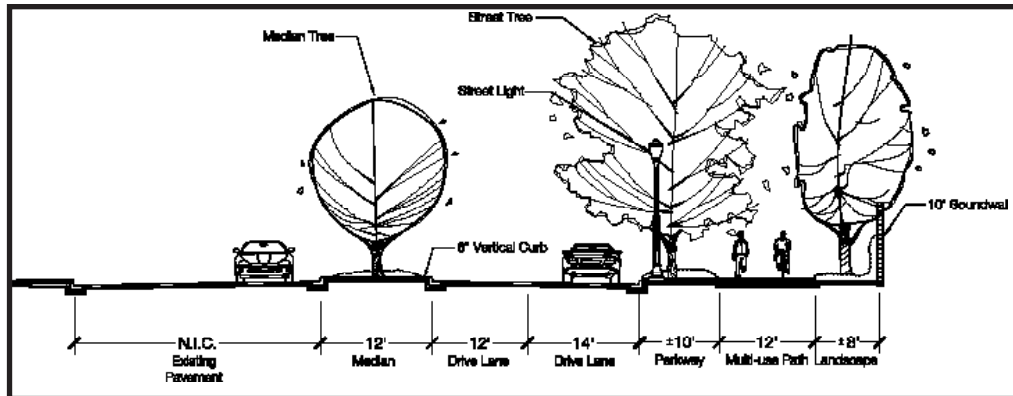

Figure D.1.3 Arterial Road - Lathrop Multi-use Trail Frontage, Section B  
Union Road- South of the Community Entries

Union Road shall be widened to its full right-of-way width of 142-feet and shall include 31.5-feet of additional landscape area on either side of the right-of-way. A general description of the typical road section is as follows:

- The provision of four travel lanes and a 12-foot center median
- Vertical curb and gutter, typical
- 10-foot parkway on both sides of the right-of-way
- 5-foot sidewalk, per City standards, to be located in the landscape strip
- Landscape easement at varying widths on either side of the right-of-way

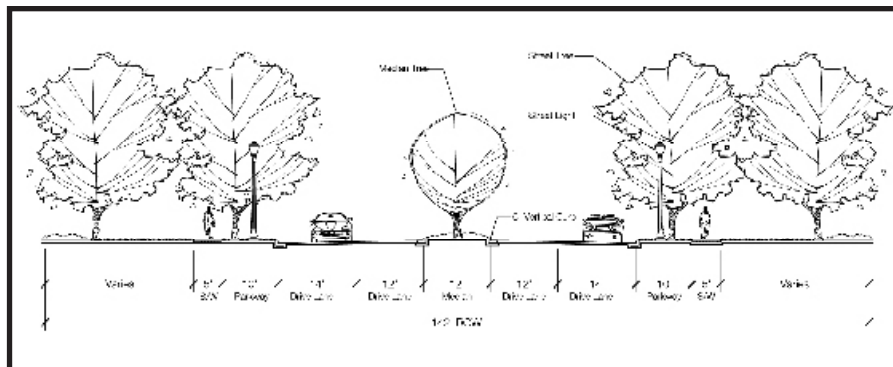

Figure D.1.4 Arterial Road - Union Road South of Community Entry, Section C

Union Road- South of the Community Entries

Union Road shall be widened to its full right-of-way width of 123-feet, a general description of the typical road section is as follows:

- The provision of four travel lanes and a 12-foot center median
- Vertical curb and gutter, typical
- 5-foot sidewalk, per City standards, to be located on both sides of the right-of-way
- 10-foot parkway strip on both sides of the right-of-way.
- 24-foot landscape easement on east side of the right-of-way.
- 5-foot landscape easement on west side of the right-of-way.

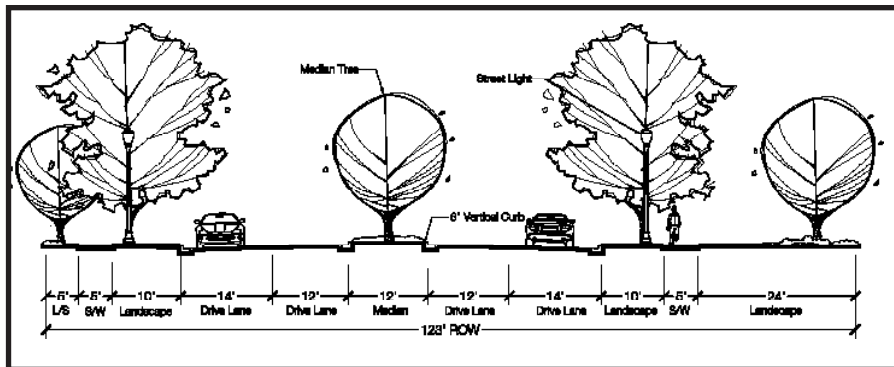

Figure D.1.5 Arterial Road - Union Road South of Community Entry, Section D

Union Road- South of the Community Entries

Union Road shall be widened to its full right-of-way width of 142-feet, a general description of the typical road section is as follows:

- The provision of four travel lanes and a 12-foot center median
- Vertical curb and gutter, typical
- 12-foot Multi-use trail, per City standards, to be located on west side of the right-of-way
- 5-foot sidewalk to be located on east side of the right-of-way

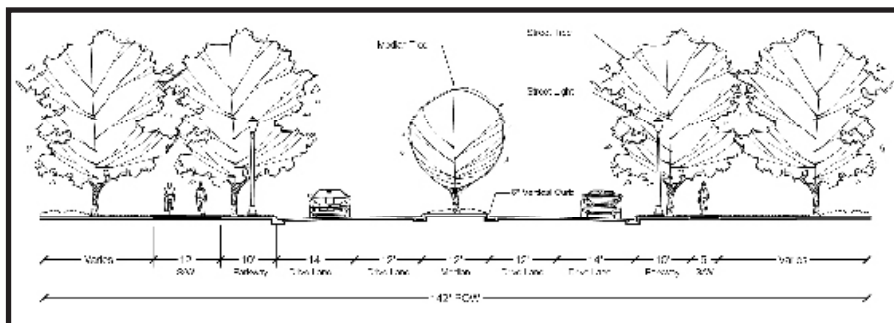

Figure D.1.6 Arterial Road - Union Road South of Community Entry, Section E

Union Road- North of the Community Entries

Union Road shall be widened to its full right-of-way width of 104-feet, a general description of the typical road section is as follows:

- The provision of four travel lanes and a 12-foot center median
- Vertical curb and gutter, typical
- 5-foot sidewalk, per City standards, to be located on both sides of the right-of-way
- 10-foot parkway strip on both sides of the right-of-way.

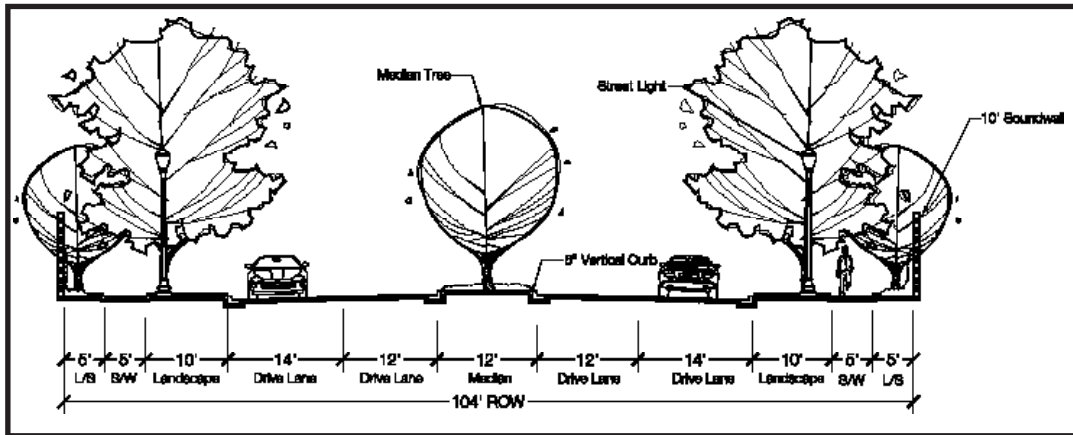

Figure D.1.7 Arterial Road - Union Road North of Community Entry, Section F

Airport Way - South of Community Entry

Airport Way shall be widened to its full right-of-way width of 140-feet, a general description of the typical road section is as follows:

- The provision of a 37.5' transition and turn lane and a 12-foot median.
- Vertical curb and gutter, typical
- 12-foot meandering bike trail/sidewalk, per City standards, to be located on east side of the right-of-way
- 7.5-foot max. parkway strip on east side of the right-of-way

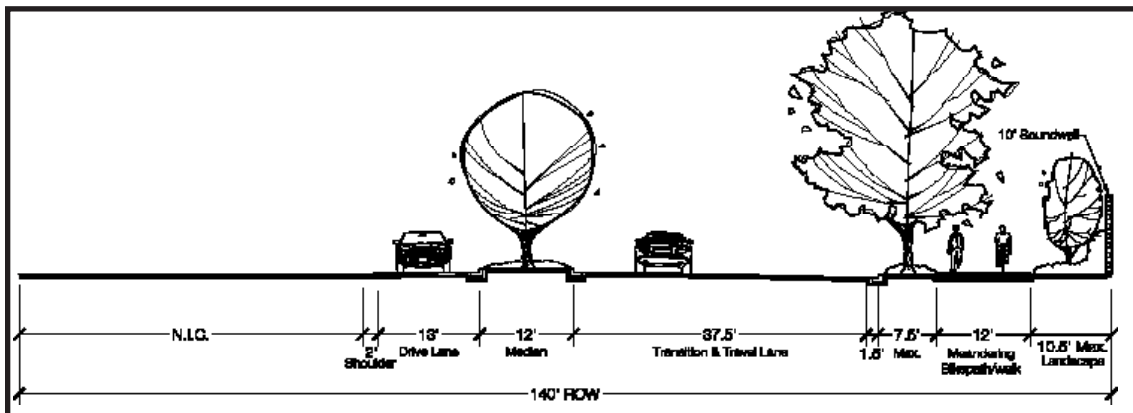

Figure D.1.8 Arterial Road - Airport Way South of Woodbridge Entry, Section G

Airport Way - North of Community Entry

Airport Way shall be widened to its full right-of-way width of 130-feet, a general description of the typical road section is as follows:

- The provision of a 37.5' transition and turn lane and a 12-foot median.
- Vertical curb and gutter, typical
- 5-foot meandering bike trail/sidewalk, per City standards, to be located on east side of the right-of-way
- 7.5-foot max. landscape area on east side of the right-of-way

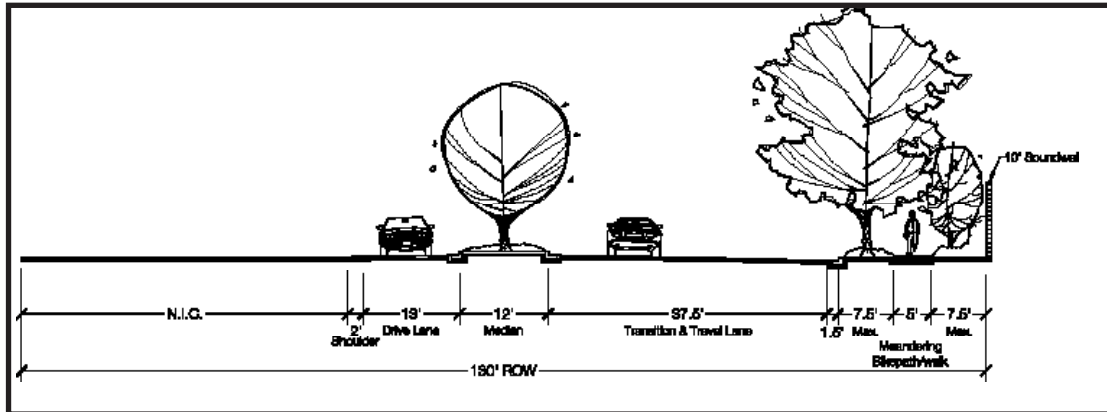

Figure D.1.9 Arterial Road - Airport Way North of Woodbridge Entry, Section H

## D.2 Proposed Right-of-Ways

Right-of-Ways are planned to provide safe and efficient circulation for automobile, pedestrian, and bicycle traffic. They also serve to define the streetscape, which when combined with landscape corridors, parkways and built elements such as walls, fences and monuments, helps to establish community character. The Union Ranch Specific Plan proposes a variety of right-of-way widths to suit site-specific conditions. These proposed right-of-ways conform to current City standards wherever possible, and where they vary from current standards they apply the design criteria described by the City of Manteca Residential Design Guidelines, dated December 3<sup>rd</sup>, 2002. A summary is as follows:

### Union Ranch East

#### Residential Collector Street, 60-foot Right-of-Way - City Standard

- Two, 14-foot drive lanes
- 8-foot parking lane, both sides of the right-of-way
- Total pavement section of 44-feet
- Rolled curb and gutter, typical
- 5-foot sidewalk, typical (monolithic)
- 3-foot easement, both sides of the right-of-way

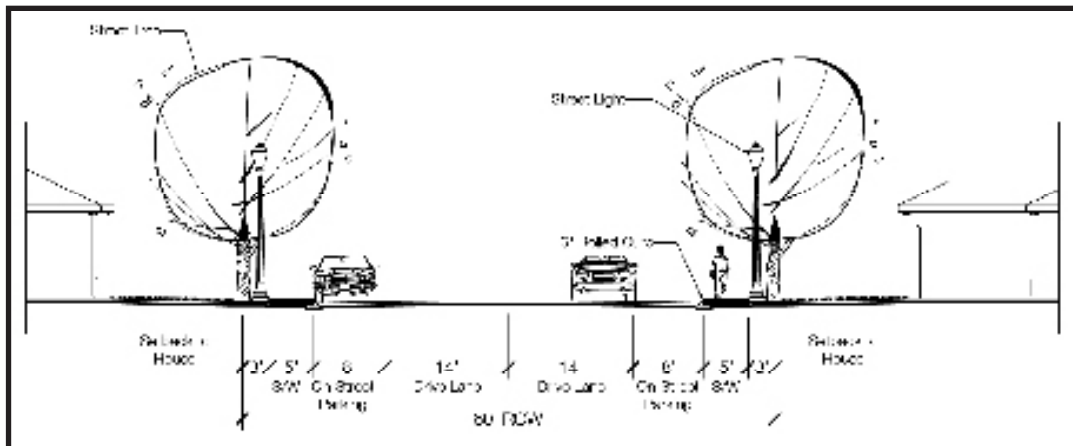

Figure D.2.1 Residential Collector - Union Ranch East, Section I

Neighborhood Street, 50-foot Right-of-Way - City Standard

- Two, 10-foot drive lanes
- 8-foot parking lane, both sides of the right-of-way
- Total pavement section of 34-feet
- Rolled curb and gutter, typical
- 5-foot sidewalk, typical (monolithic)
- 2-foot easement, both sides of the right-of-way

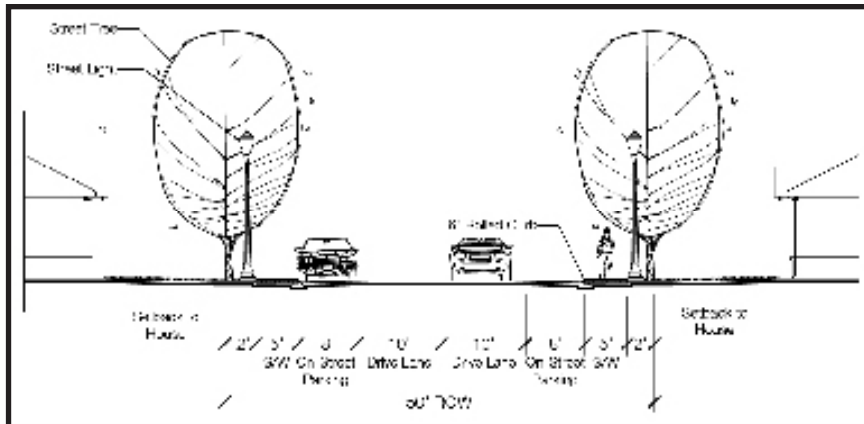

Figure D.2.2 Neighborhood Street - Union Ranch East, Section J

Neighborhood Street at the Tidewater Open Space Corridor, 50-foot Right-of-Way

- Two, 10-foot drive lanes
- 8-foot parking lane, both sides of the right-of-way
- Total pavement section of 36-feet
- Rolled curb and gutter, typical
- 5-foot sidewalk, typical (monolithic)
- 3-foot easement, both sides of the right-of-way
- Open Space Corridor with 12-foot meandering path

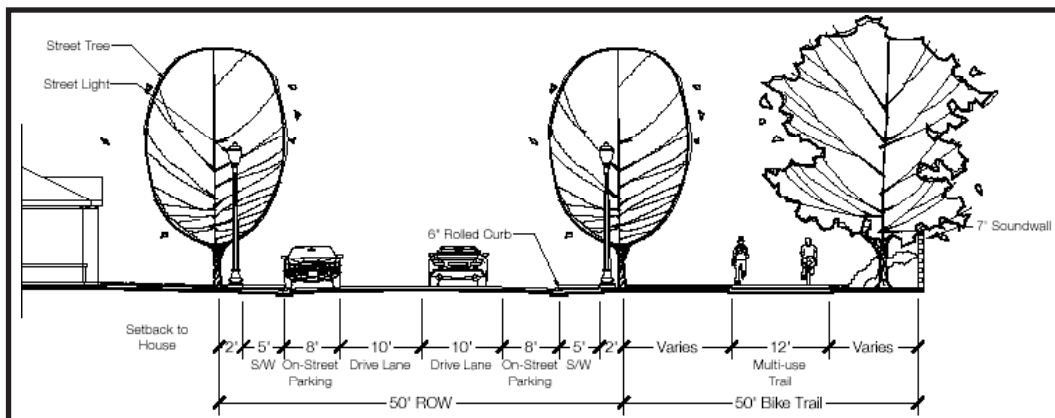

Figure D.2.3 Neighborhood Street at Tidewater Trail- Union Ranch East, Section K

Woodbridge by Del Webb

Major Residential Collector, 120-foot Right-of-Way

- Four, 12-foot travel lanes and a 12-foot center median
- 5-foot Class II designated bike lane, both sides of the right-of-way
- Total pavement section of 72-feet
- Vertical curb and gutter, typical
- 6-foot parkway strip, both sides of the right-of-way
- 5-foot separate sidewalk, both sides of the right-of-way
- Landscape area at varying widths

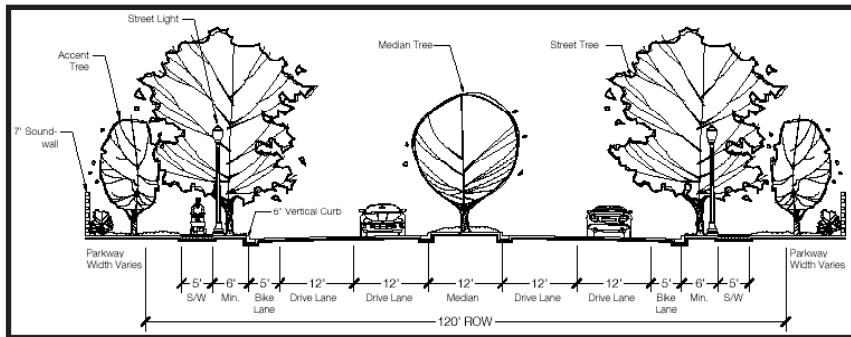

Figure D.2.4 Major Residential Collector Street - Woodbridge by Del Webb, Section L

Cul-de-Sac Street, 52-foot Right-of-Way

- Two, 10-foot travel lanes
- Two, 7-foot parking lanes
- Rolled curb and gutter, typical
- Total pavement section of 34-feet
- 5-foot parkway strip, both sides of the right-of-way
- 4-foot separate sidewalk, both sides of the right-of-way

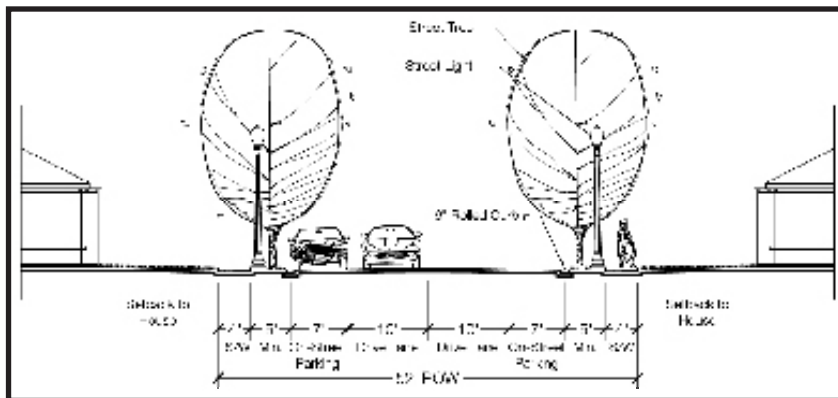

Figure D.2.5 Cul-de-Sac Street - Woodbridge by Del Webb, Section M

Neighborhood Street at Parkway, 54-foot Right-of-Way

- Two, 10-foot travel lanes
- Two, 7-foot parking lanes
- Rolled curb and gutter, typical
- Total pavement section of 34-feet
- 6-foot parkway strip, one side of the right-of-way
- 4-foot separate sidewalk, one side of the right-of-way
- 12-foot meandering bike trail located in open space corridor of varying width, one side of the right-of-way

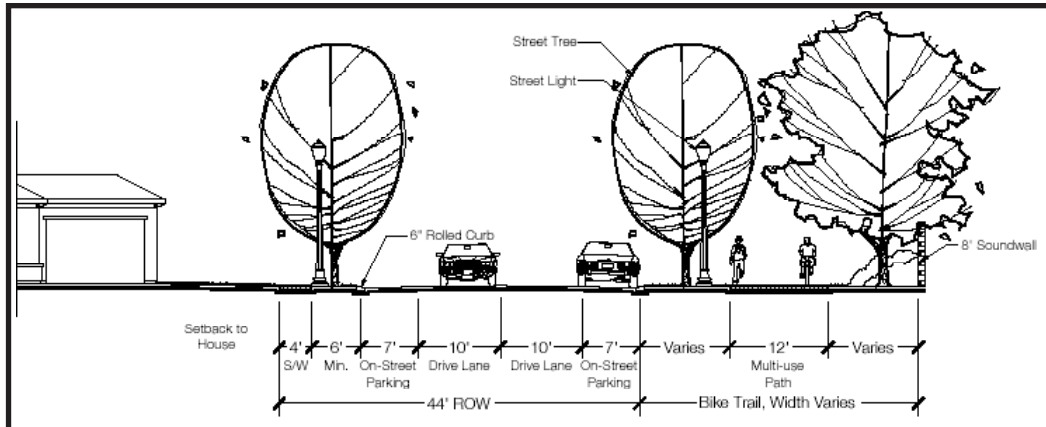

Figure D.2.6 Neighborhood Street at Parkway - Woodbridge by Del Webb, Section N

Typical Neighborhood Street, 54-foot Right-of-Way

- Two, 10-foot travel lanes
- Two, 7-foot parking lanes
- Rolled curb and gutter, typical
- Total pavement section of 34-feet
- 6-foot parkway strip, both sides of the right-of-way
- 4-foot separate sidewalk, both sides of the right-of-way

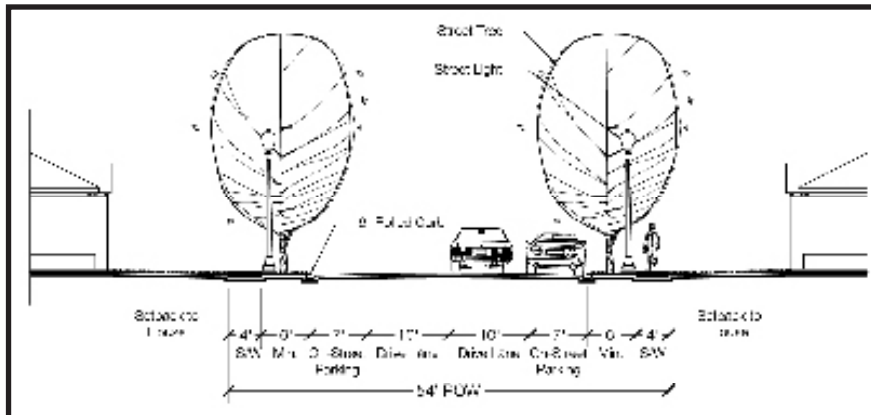

Figure D.2.7 Neighborhood Street - Woodbridge by Del Webb, Section O

Typical Neighborhood Street at Parkway, 54-foot Right-of-Way

- Two, 10-foot travel lanes
- Two, 7-foot parking lanes
- Total pavement section of 34-feet
- Rolled curb and gutter, typical
- 6-foot parkway strip, one side of the right-of-way
- 4-foot separate sidewalk, one side of the right-of-way
- 12-foot meandering bike trail located in open space corridor of varying width, one side of the right-of-way

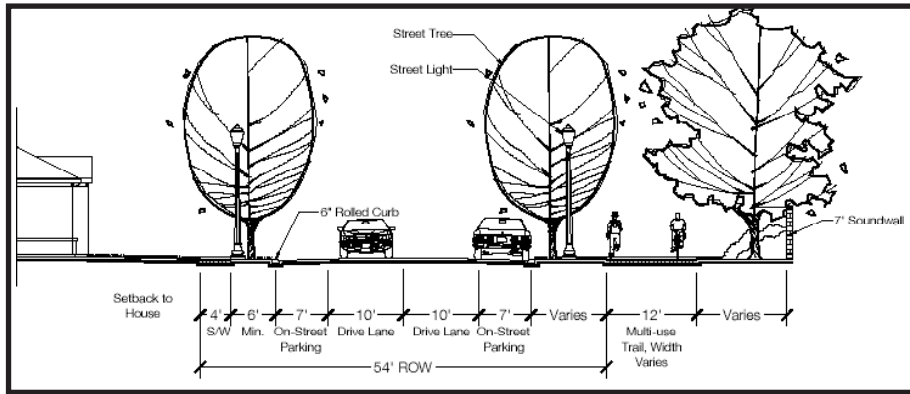

Figure D.2.8 Neighborhood Street at Parkway - Woodbridge by Del Webb, Section P

Bike Trail- Rear Yard, Varying Right-of-Way

- 12-foot meandering multi-use path
- Open space corridor landscaping-varying overall width, see figure D.4.1

Residential Collector Street, 60-foot Right-of-Way

- Two, 10-foot travel lanes
- Two, 7-foot parking lanes
- Rolled curb and gutter, typical
- Total pavement section of 34-feet
- 5-foot parkway strip, both sides of the right-of-way
- 5-foot separate sidewalk, both sides of the right-of-way

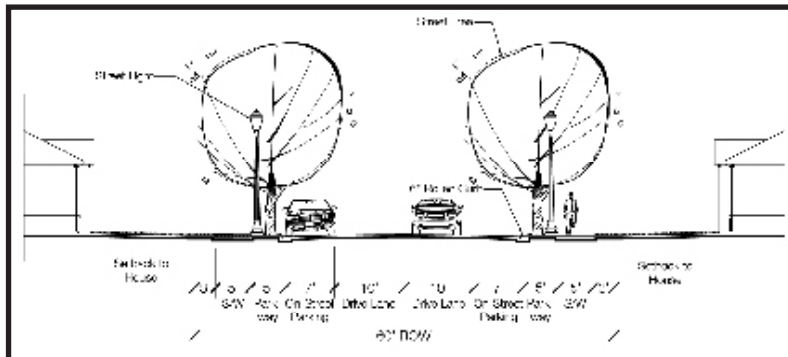

Figure D.2.9 Residential Collector Street - Woodbridge by Del Webb, Section Q

Residential Collector Street, 60-foot Right-of-Way

- Two, 14-foot travel lanes
- Rolled curb and gutter, typical
- 6-foot parkway strip on both sides of the right-of-way
- 5-foot separate sidewalk on both sides of the right-of-way
- 5-foot landscape easement between sidewalks and soundwalls

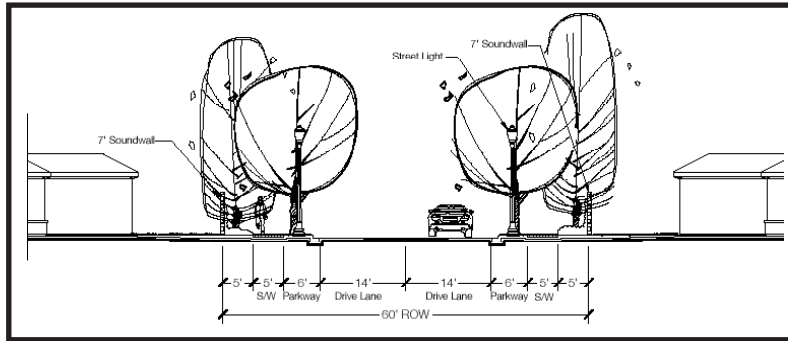

Figure D.2.10 Collector Street w/Soundwall on 2 Sides- Woodbridge by Del Webb, Section R

Residential Collector Street, 60-foot Right-of-Way

- Two, 14-foot travel lanes
- Rolled curb and gutter, typical
- 8-foot on-street parking on north sides of the right-of-way
- 5-foot monolithic sidewalk on north side of the right-of-way
- 5-foot separated sidewalk on south side of the right-of-way
- 3-foot landscape easement between sidewalk and residential right-of-way
- 5-foot landscape easement between sidewalk and soundwall

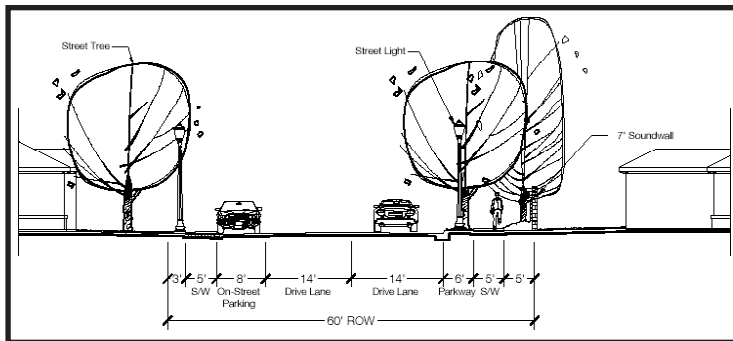

Figure D.2.11 Collector Street w/Soundwall on 1 Side- Woodbridge by Del Webb, Section S

Residential Collector Street, 60-foot Right-of-Way

- Two, 14-foot travel lanes
- Total pavement section of 44-feet
- Rolled curb and gutter, typical
- 8-foot on-street parking on both sides of the right-of-way
- 5-foot monolithic sidewalk on both sides of the right-of-way
- 3-foot landscape easement between sidewalk and residential right-of-way

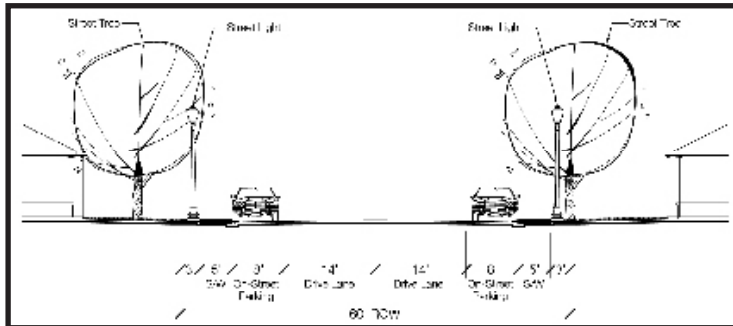

Figure D.2.12 Collector Street w/Parking on 2 Sides - Woodbridge by Del Webb, Section T

D.3 Non-Vehicular Circulation

A comprehensive system of multi-use paths and bikeways is proposed for the Plan Area to allow for safe and convenient access between land uses. The goal is to encourage pedestrian activities and bicycling as an alternative to traditional automobile usage. Class I bike trails are proposed (as part of a 12-foot multi-use path system) within Open Space Corridors that traverse the Plan Area in a north-south and east-west orientation. Access to the Class I bike trail is provided via neighborhood streets, arterial roads and residential collector streets. Figure D.1.1 illustrates this arrangement. Class II bike lanes shall be striped on designated streets within the Plan Area, (see street sections in subsection D.2 for more information) and Class III routes may be designated on residential streets during tentative mapping to provide additional connectivity. Bike trails are defined as follows:

Class I - Provides a minimum of 12-foot multi-use path.

Class II- Provides a paved striped land at the edge of a street or road for one-way bike travel.

Class III- Provides a shared use with vehicular traffic on a residential street

The extensive bikeway system within the Plan Area will provide opportunities to connect with

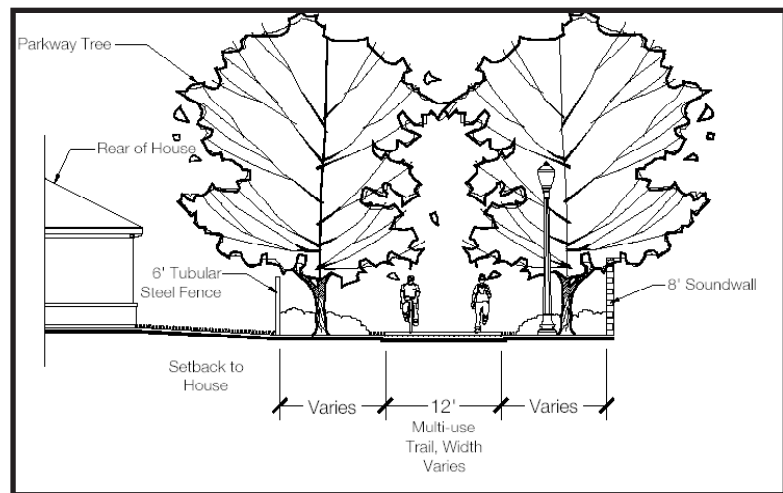

Figure D.3.1 Bike Trail - Rear Yard, Section U

existing and proposed bikeways in adjacent developments, including a primary connection to downtown Manteca via the Tidewater Open Space Corridor. Tentative mapping for residential projects shall be designed to ensure a positive and safe orientation toward open space, with roadway access provided adjacent to Open Space Corridors, see Figure D.1.1, or with rear yard orientations complete with see-through view fencing as illustrated by the Bike Trail- Rear Yard, Varying Right-of-Way exhibit found in subsection D.2. The orientation of cul-de-sac streets perpendicular to Open Space Corridors, with openings in the soundwall wall and fencing, will also allow for ease of public access.

#### D.4 Public Transit

Existing public transit bus stops are provided at Union Road/Lathrop Road. The Plan will support the use of these facilities by providing for an enhanced, protected bus stop facility with identifying signage. Future public transit stops will be predicated on the City of Manteca and their desire to increase the level of service. Bus turn-outs will be designed in the tentative maps on arterial streets, on the far side of each major intersections and at the entries to Union Ranch East and Woodbridge, in coordination with City of Manteca standards.

---

## Section E. Public Facilities

This section addresses the general public facilities required to serve the future residents of the Plan Area. It includes a description of police protection/law enforcement, fire protection, solid waste disposal, as well as parks and recreation facilities. This section includes a list of standards for each public service. Funding for these public facilities shall be provided by the current fee programs. Woodbridge by Del Webb is an active adult community unique to Manteca and, as such, has varying impacts on public facilities that differentiate it from a standard R-1 subdivision. Woodbridge will generate less water consumption, wastewater flow, traffic and therefore street maintenance costs, and police service costs than a conventional single-family housing development. Gruen Gruen + Associates of San Francisco has studied the fiscal impacts of Woodbridge on City of Manteca services and determined that the project will generate additional City revenue of approximately \$434,000 above the cost of services. A complete analysis of the fiscal impacts and methodology used can be found in the supplemental report; "An Analysis of the Fiscal Impacts of the Proposed Woodbridge Active Adult Development," dated February 2004.

### E.1 Police Protection/Law Enforcement

The Manteca Police Department is a full service municipal law enforcement agency with specialized assignments and recognized specialties. In addition, the Department has an active and valuable volunteer staff consisting of Police Explorers, Reserve Officers, and senior citizens who render invaluable assistance to the Department and the community. In compliance with other goals and policies in the Specific Plan, the commercial areas and neighborhoods will be designed to encourage pedestrian activity. This will require a higher level of attention and care for the design of public spaces to ensure that there is adequate opportunity for surveillance by the police and general public.

The City meets a standard of one sworn officer per 1000 residents. No additional facilities will be required in the plan area.

#### E1.1 Law Enforcement Standards

- A) The City shall endeavor through adequate staffing and patrol arrangements to maintain the minimum feasible response time for police calls.
- B) The City shall provide police services to existing and projected population, including the Union Ranch Specific Plan Area.
- C) The Planning Commission and City Engineer will review proposed residential street patterns to evaluate the accessibility for police patrols and emergency response.
- D) Residential-based surveillance and law enforcement notification programs, such as Neighborhood Watch, are strongly encouraged.
- E) All land uses in the plan area should be designed to facilitate surveillance and access by law enforcement equipment and personnel.
- F) Streets shall be designed and constructed to ensure that emergency response is not impaired.

---

## E.2 Fire Protection

The Manteca Fire Department (MFD) provides fire services in the City of Manteca. The Insurance Services Office (ISO) has rated Manteca as a Class 3 on a scale of 9. Manteca shares the second best rating in the County and is rated in the top 15% of fire departments in San Joaquin County. Currently there are three fire stations in Manteca, with the closest existing station located at 800 East J St. Lathrop, CA (2) two miles from the Union Ranch Plan Area. A fire station is proposed for the Plan Area, located on a 1-acre parcel on the west side Union Road, north of the primary community entries.

The Manteca Fire Department also provides emergency medical response. To maintain a standard level of care all fire personnel are trained and certified Emergency Medical Technician-1 (EMT) and EMT-D. There are two emergency care hospitals in Manteca, with the closest located at E. North Street-- approximately eight miles from the Union Ranch Plan Area.

### E.2.1 Fire Protection Standards

- A) The City has identified a goal to maintain an overall fire insurance (ISO) rating of 4 or better.
- B) The City shall provide fire services to serve the existing and projected population.
- C) The Fire Department shall continuously monitor response times and report annually on the results of the monitoring.
- D) The Planning Commission and City Engineer will review proposed residential street patterns to evaluate the accessibility for fire engines and emergency response.

## E.3 Solid Waste Disposal

The City of Manteca Solid Waste Department shall provide weekly solid waste disposal and recycling services for the Plan Area. The City utilizes the Forward Landfill Inc. to process and ship its solid waste and materials. Green waste is also delivered to the Austin Road/Forward Landfill. This landfill has a closure date of 2053 and has a remaining capacity of 1,608,752 cubic yards.

### E.3.1 Solid Waste Disposal Standards

- A) The City shall provide residential recycling picked up on a bi-weekly schedule and regular weekly garbage removal.
- B) Residential bi-weekly curbside pickup of compost materials.
- C) Leaf and Christmas Tree pickup.
- D) Oil collection containers picked up on a weekly basis.
- E) Commercial recycling made available.
- F) Household Hazardous Waste collection.

## E.4 Park Facilities

The Manteca General Plan states that the primary objective of park improvements is to provide recreational amenities for all residents. A secondary objective is to provide space for public gatherings that may attract visitors to the community by ensuring that parks serve a variety of uses. For the parks in Manteca to meet the primary recreation-based objective park facilities

need to be designed with local neighborhoods in mind. To this end the Union Ranch Plan Area proposes a total of 69.45-acres of open space and parkland, including bike trails and private recreation center, with a total public parkland dedication of 23.78- acres for shared storm water detention and recreational amenity. Park facilities standards are presented here in complete support of the 2023 General Plan policies and implementation procedures, including the provision of 5-acres of community parkland for every 1000 projected residents and 3.5 acres of neighborhood park for every 1000 projected residents. A summary is as follows in Table E.4.1:

Table E.4.1.1 Open Space &amp; Park Amenities

Open Space & Park Amenities	Neighborhood Park Park A	Neighborhood Park B (Woodbridge by Del Webb)	Neighborhood Park C (Union Ranch East)	Open Space Trails and Pathways
Basketball Court			X	
Tot Lot Play Equipment		X	X	
Adventure Play Equipment		X	X	
Picnic/BBQ	X	X	X	
On-street Parking	X	X	X	
Pavilion/Picnic Shelter	X		X	
Pavilion/Exhibition Space		X		
Picnic Tables	X	X	X	
Walk/Jog Trail	X	X	X	X
Irrigation System	X	X	X	
Multi-Use Turf Area	X	X	X	
Sculpture/Art Work	X	X	X	
Bike Trail	X		X	X
Drinking Fountain(s)	X	X	X	
Site Furnishings (benches, trash receptacles)	X	X	X	X
Security Lighting	X	X	X	X
Distinctive Pedestrian Entry (s)	X	X	X	
Drainage Basin Easement	X	X	X (dedicate)	X
Landscape Improvements	X	X	X	X
Signage	X	X	X	X
Acreage	5.41	8.9	9.5	32.16

Park A:

Woodbridge by Del Webb, 5.4 acres with a total detention capacity of 8.8 acre-feet.

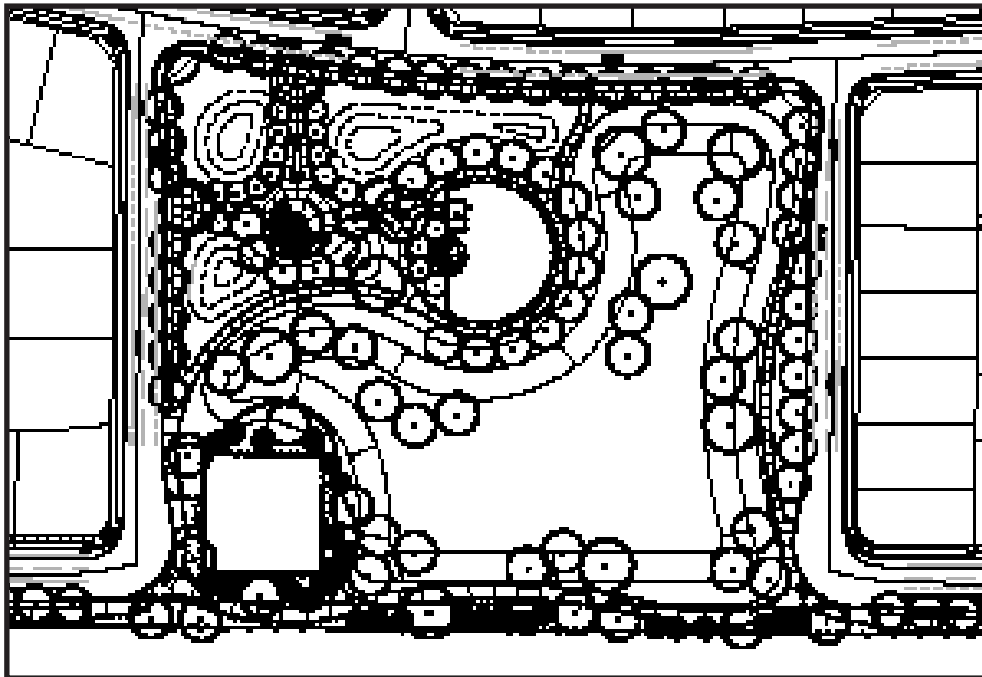

Figure E.4.1.1 Park Site A

Park B:

Woodbridge by Del Webb, 8.9 acres with a total detention capacity of 16.4 acre-feet.

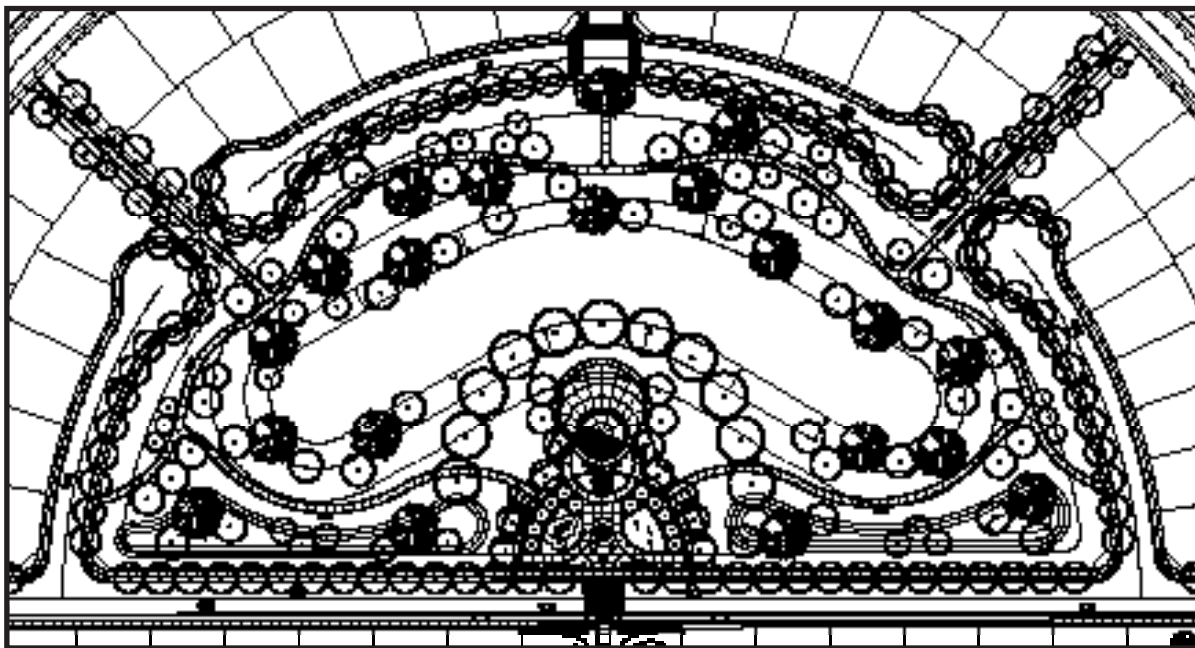

Figure E.4.1.2 Park Site B

## Park C:

Union Ranch East, 9.5 acres with a total detention capacity of 14.3 acre-feet.

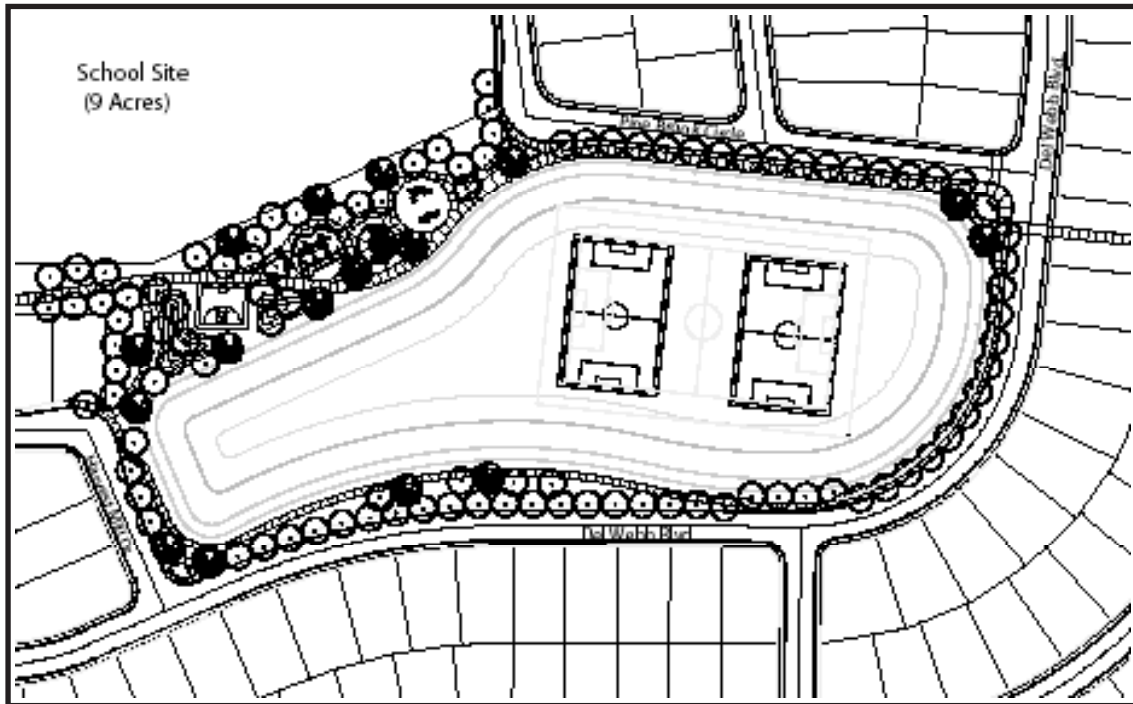

Figure E.4.1.3 Park Site C

#### E.4.1 Park Financing, Dedication and Maintenance

Park C and the Tidewater Trail right-of-way will be dedicated to the City of Manteca for access by all City residents. Each shall be designed and improved to permit development of the improvements identified in the conceptual park plans illustrated in Table E.4.1.1. The City acquires and improves parks through the collection of fees as authorized under the Development Mitigation Act (G.C. 66010-66037) Park C land is to be dedicated to the City and developed with park improvements.

Parks A and B, and some portions of the open space trail system within Woodbridge, shall be constructed by Pulte Home Corporation and maintained by a Home Owner's Association established by Pulte Home Corporation. Fees for the maintenance of these facilities, which shall be developed to meet specific recreational needs of the active adult community, will be the responsibility of the Home Owner's Association. The general public will have access to Park C, as well as the Open Space/Trail System located in Woodbridge by Del Webb. Park facility standards shall in all cases meet and/ or exceed City of Manteca standards.

#### E.4.2 Private Recreation Facilities

The recreation needs of an active adult community differ from those of a conventional community. Typically, a variety of uses are provided in park or community center catering to a diverse demographic of users groups and active uses generally outweigh the demand for passive uses. Conversely, in an active adult community less emphasis is placed on physically demanding activities, and more emphasis is placed on social interaction. A higher recreational priority is placed on smaller scale facilities that are aesthetically pleasing and promote leisure and fitness tailored to that age group.

Woodbridge by Del Webb provides for two private Parks A & B, and a 13.5-acre private recreational facility, at the center of the community (Refer to Figure E.4.2.1). The focus of the facility is a recreation lodge containing swim facilities, social rooms, work-out facilities, a library and craft-rooms. Active recreation opportunities within the center are tailored to the desires of an active adult community, and include a softball field, bocce courts, a tennis facility, and passive uses such as a contemplative garden, all surrounding a major lake feature. Fees for the maintenance of these facilities will be the responsibility of the Home Owner's Association. The general public will not have access to the recreation center and associated facilities—access will be limited to residents and their guests.

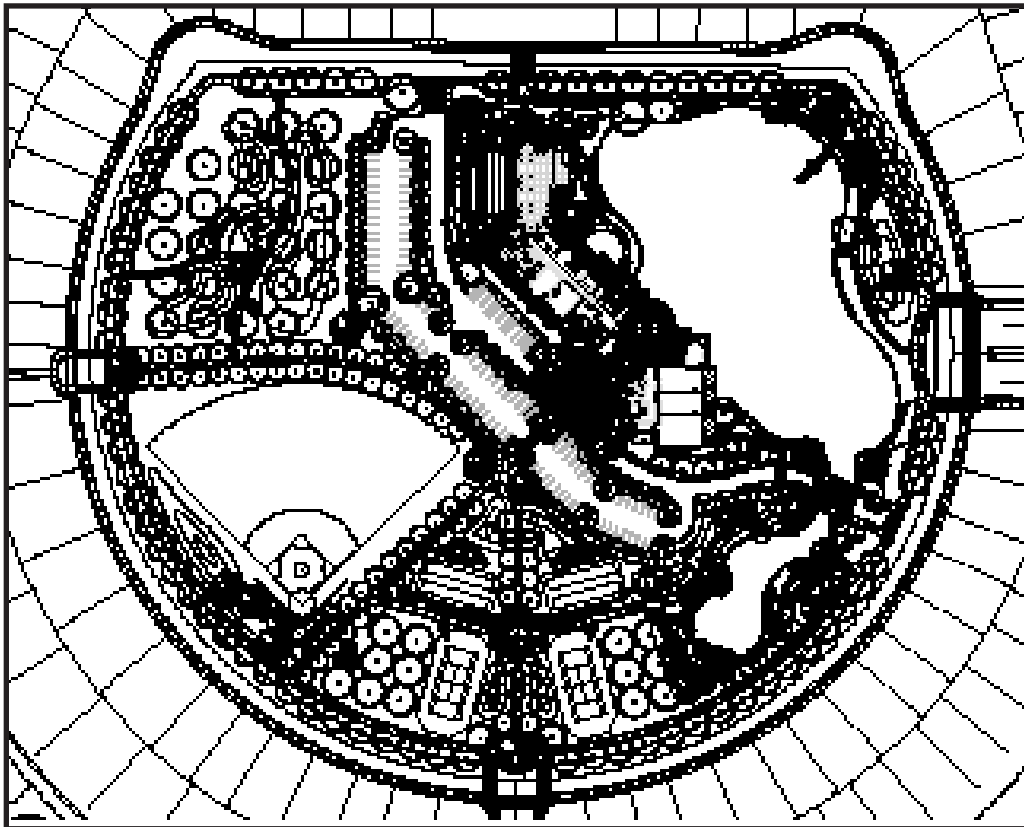

Figure E.4.2.1 Recreational Center

## Section F. Infrastructure

### F.1 Water Master Plan

The City of Manteca currently provides domestic water to its customers via a network of wells and transmission lines which draw groundwater and distribute it throughout the City. While the City of Manteca has historically met all of its water needs in this manner, it is currently involved in a joint project with the South San Joaquin Irrigation District, the City of Lathrop, the City of Tracy, and the City of Escalon to develop a surface water source which will supplement the current groundwater source. The project, named the South County Surface Water Supply Project (SCSWSP), is currently under construction and will include a water treatment plant and approximately 40 miles of pipeline that will deliver treated surface water to all of the aforementioned cities.

The SCSWSP is scheduled to deliver water in late 2005. In order to develop more water resources to allow the existing City water system to meet the demands of the Union Ranch project, the project will include the construction of a new domestic water well. The well is proposed to be constructed in the northeast corner of the South San Joaquin Irrigation District's (SSJID) water storage tank site, located on Lathrop Road east of Union Road if the test well verifies it to be a suitable location. If that site is deemed unsuitable, the developer will locate an alternate site that is acceptable to the City. The well will supplement the City of Manteca's water supply. The City has determined that such supplementation is required.

The Union Ranch project will be served by the extension of two existing City water mains to the project site. The existing 12-inch water line in Lathrop Road will be extended to the project site. The existing 12-inch water line at the intersection of Lathrop Road and Airport Way will be extended northward in Airport Way adjacent to the project frontage. These extensions will result in a 12-inch line loop. This looped system will be the backbone network throughout the project site.

The Union Ranch project water distribution system will be developed in phases throughout the site. Each phase will connect to a 12-inch diameter water transmission line and other connection points in preceding phases. This continuously looped system of water mains will provide for the necessary fire flows and line pressures in conformance with City of Manteca standards. The system will be designed and constructed in conformance with City of Manteca standards for materials and installation. The Master Water Plan for Union Ranch is included herein as figure F.1.1

### F.2 Sanitary Sewer Master Plan

The City of Manteca currently provides sanitary sewer service to its customers via a network of collection of gravity and force main sewer lines. Several pump stations and lift stations located throughout the City augment this sewer line network. This conveyance system terminates at the City of Manteca Wastewater Quality Control Facility, located in the southwest area of the City. The facility has a capacity of 6.95 million gallons per day (mgd) and treats wastewater via a secondary activated sludge process. The facility will be expanded to a capacity of 10 mgd by 2005 and has an ultimate expansion capacity of 25 mgd.

The collection system for the Union Ranch project will consist of a network of gravity sewer lines ranging in size from 6" to 15" in diameter. The collection system will flow generally from east to west, more or less with the existing slope of the project site. A 15" line will terminate at Airport Way. Ultimately, it will connect to a larger sewer trunk line to be constructed at a future date pending completion and implementation of the City of Manteca's Sanitary Sewer Master Plan improvements. Union Ranch developments will pay sewer collection fees (PFIP) to cover the project's share of future use of the trunk lines. See figure F.2.1 Partial City Sewer Plan contained herein.

Until master plan improvements are complete, an interim solution for conveying wastewater generated by Union Ranch to the existing City of Manteca collection system is needed. The closest point of connection to the City's collection system is approximately 1000 feet north of the intersection of Airport Way and West Yosemite Avenue. This point of connection is approximately 11,000 feet south of the intersection of Airport Way and Lathrop Road. An existing sanitary sewer system containing a 12" force main and two pump stations is located in Airport Way approximately 4,000 feet south of the Union Ranch site. This existing 12" force main has the capacity to receive and convey the effluent from the Union Ranch project to the City's aforementioned connection point. There is some concern that Union Ranch may not legally tie into the existing 12" force main. If that is the case, the force main from Union Ranch will extend south to the point of connection 1000' +/- north of Yosemite Avenue. A temporary pump station sized to serve 1396 homes in the Union Ranch development area will be constructed at the southwest corner of the Union Ranch project, along the Airport Way frontage. This pump will be replaced with a facility capable of ultimately discharging 6.7 +/- mgd (peak) and have pumping capacity to serve the entire Union Ranch Specific Plan area, as well as

1. The area bounded by Lathrop Road on the south, Lathrop City limits on the west, Roth Road on the north and Airport Way on the east, plus
2. The area bounded by Lathrop Road on the south, Airport Way on the west, Lovelace Road on the north and the northerly extension of the Tidewater Bikeway on the east.

with a 24" force main extending to the point of connection 1000' +/- north of Yosemite Avenue. The ultimate regional sanitary sewer pump station shall initially consist of the ultimate wet well, above ground structures and fenced yard required to serve the entire Union Ranch Specific Plan area plus the areas specified in 1 & 2 above with initial pumping capacity to serve only the Union Ranch Specific Plan area. The initial pumping capacity shall be expandable to serve the entire Union Ranch Specific Plan area plus the areas specified in 1 & 2 above. Upon completion of the gravity trunk line in Airport Way, the 12" force main and temporary pump station will be abandoned per the City's requirements.

The City of Manteca Standard Plans and Specifications were used to determine wastewater flows for this master plan. Per City of Manteca Standard Drawing No. S-2, an average flow of 330 gallons / residence / day was used on the portion of the project located east of Union Road (3.3 persons per lot @ 100 gallons / person / day). Since the lots on the west side of Union Road will be developed for 2 bedroom senior housing only, an average flow of 173 gallons/residence/day was used for these 1,425 lots (2.0 persons per lot @ 86.5 gallons/person/day). The average daily flow of 173 gallons/person/day is obtained from City Resolution No. R2004-22, a resolution of the City Council of Manteca, California, establishing a Phase 3 point rating

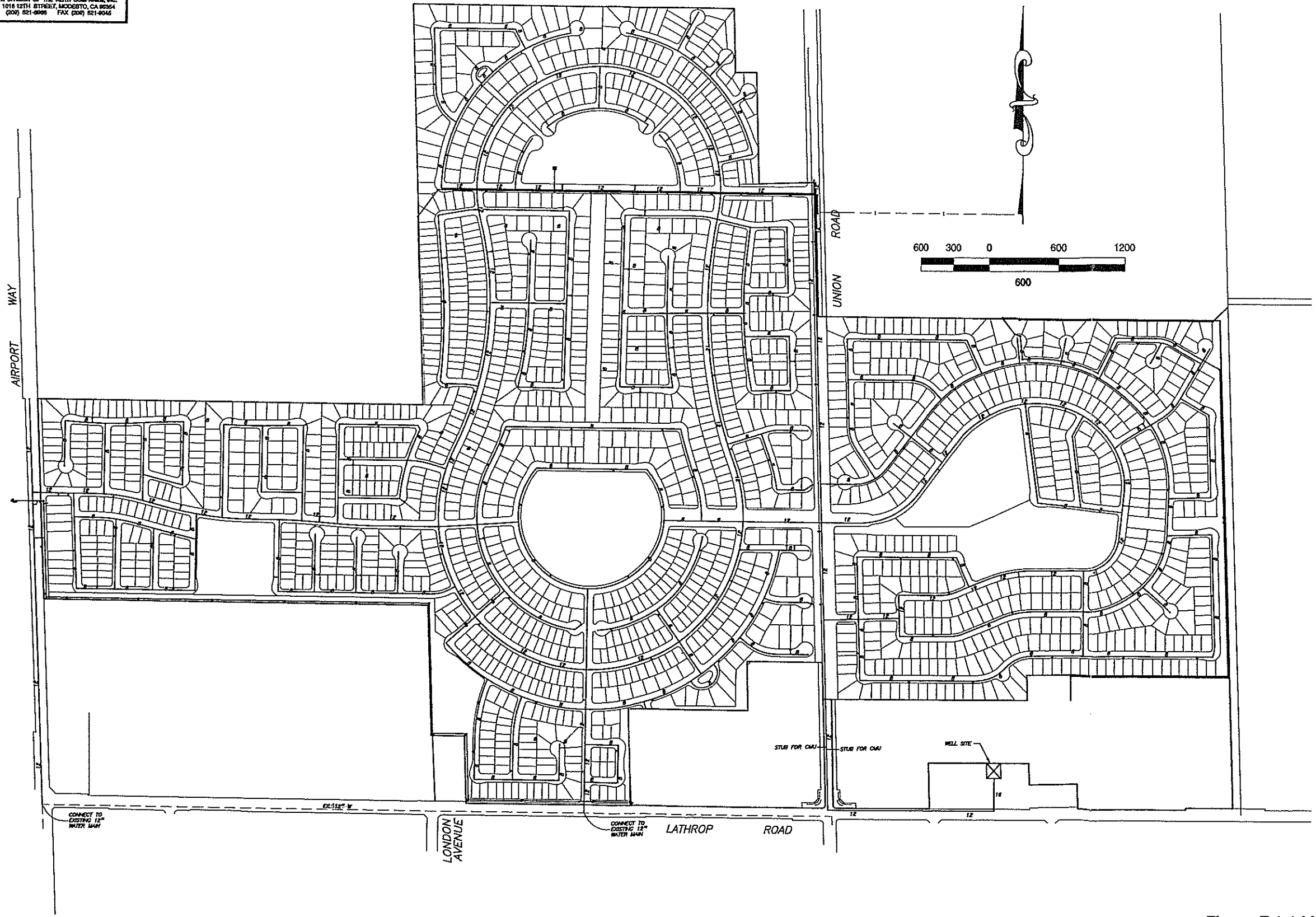
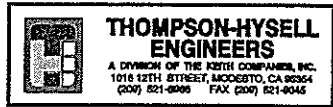

Figure F.1.1 Master Water Plan

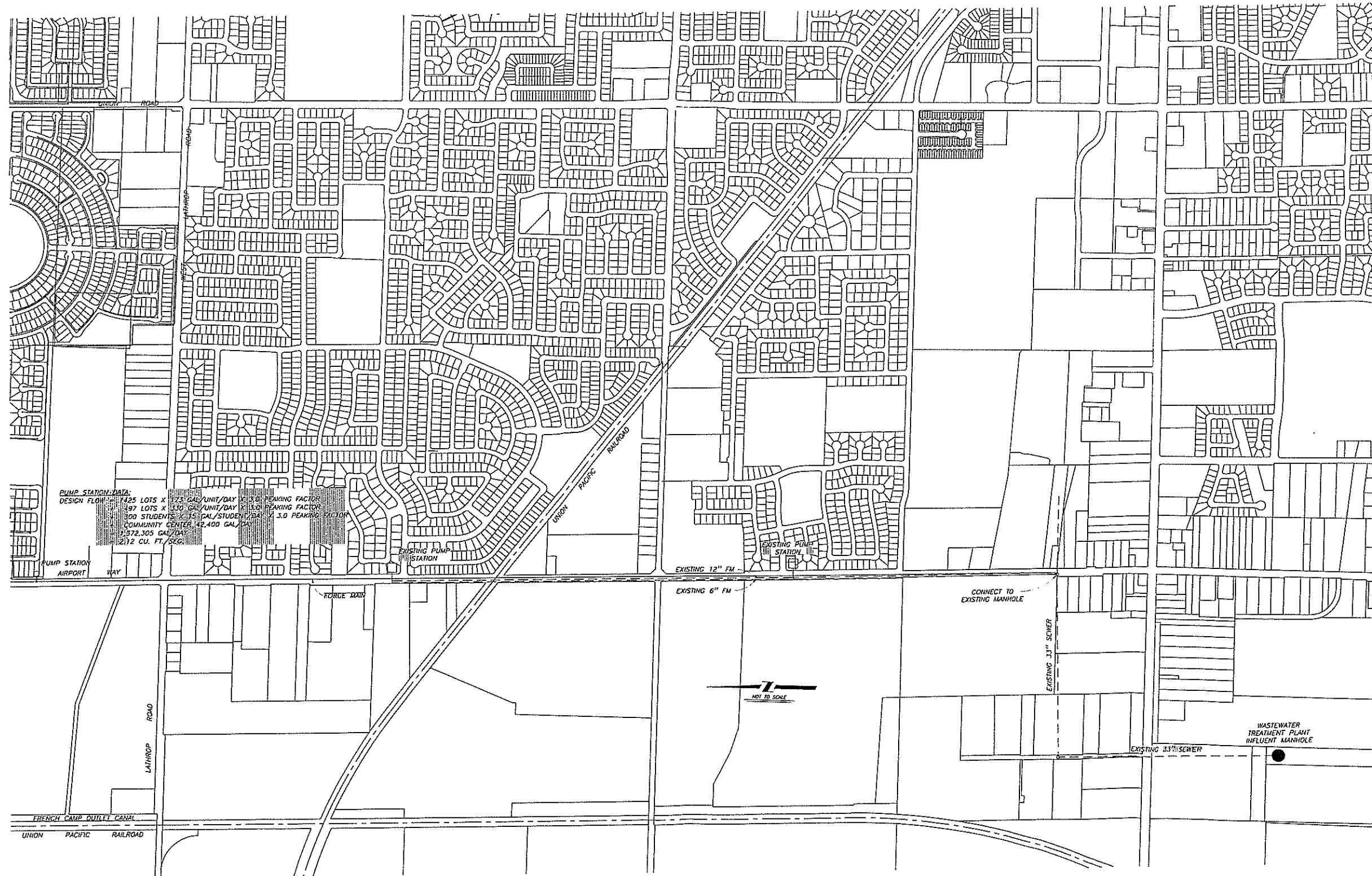

Figure F.2.1 Partial City Sewer Plan

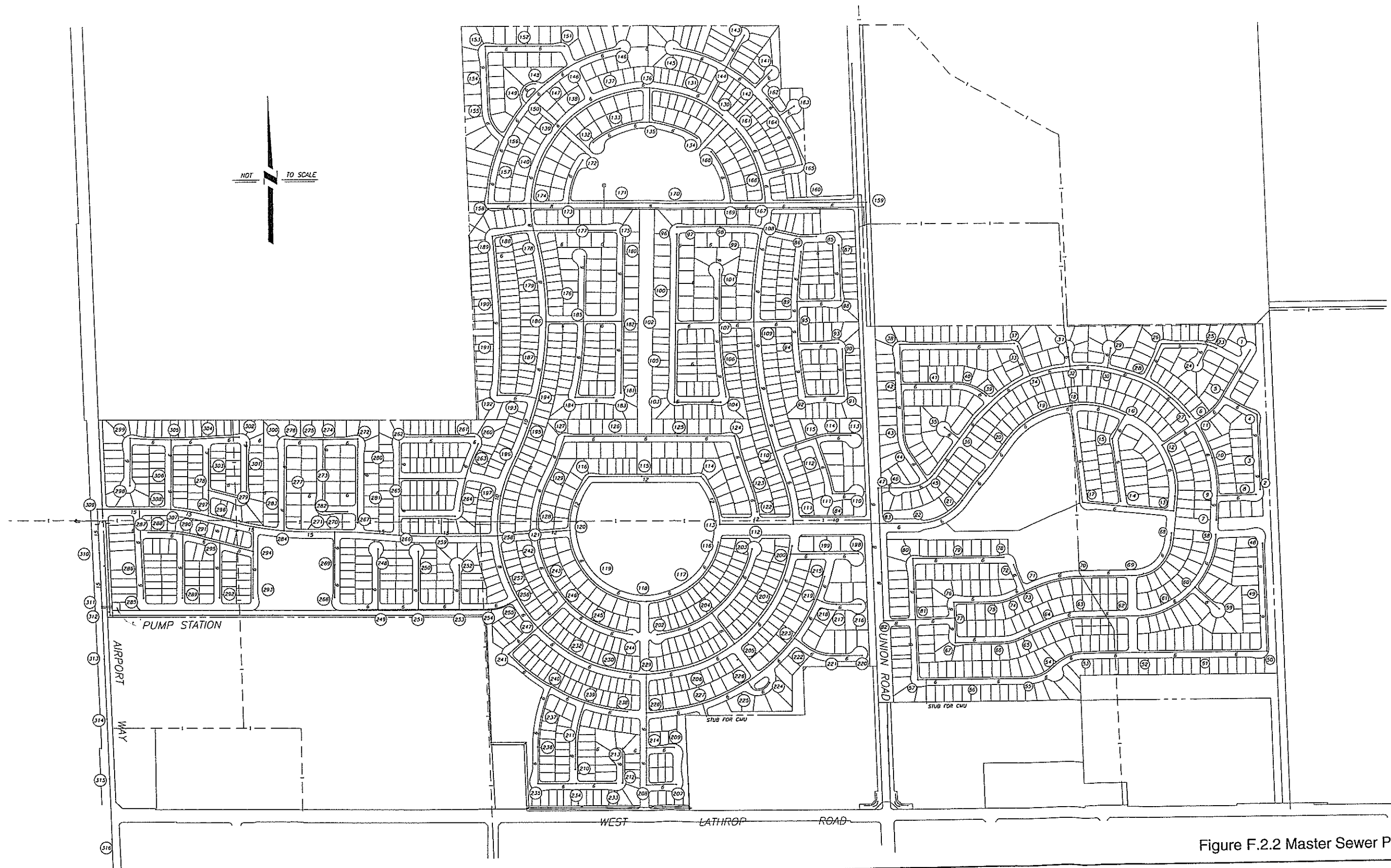

Figure F.2.2 Master Sewer Plan

system pursuant to Article 18 (revised community growth management program) of the Manteca Municipal Code. Per the proposed land plan, there will be 535 traditional single-family units located east of Union Road and 1,425 single-family units located west of Union Road resulting in 1960 residential units in the Union Ranch project, with approximately 4,615 residents. A peaking factor of 3.0 was used per the chart on Standard Drawing No. S-2.

This Sewer Master Plan has been designed to accommodate 97 acres of Very Low Density Residential (2 dwelling units / acre) north of and adjacent to Union Ranch on the east side of Union Road. An Area of Benefit will be created to distribute appropriate cost sharing to development that benefits in the future.

Additionally, wastewater flows from the centrally located community center of the Union Ranch project were calculated per City of Manteca Standard Drawing No. S-2 for commercial development. However, since the development plan for the community center includes only one commercial building within the 13.5 acres, the City standards for a recreation building of 25,000 square feet were used to calculate the wastewater flow. This resulted in an effluent discharge from the recreation building in the community center of 42,400 gallons per day peak flow, or approximately equivalent to 43 single-family residential units.

The Union Ranch project sanitary sewer collection system will be developed in phases throughout the site. Each phase will discharge into the internal collection lines extending to the 15-inch diameter sewer trunk line and the temporary pump station. The 15-inch diameter sewer trunk line, temporary pump station, and 24-inch diameter force main will be constructed during the first phase of development. The Sewer Master Plan has been designed to receive and convey wastewater flows from the plan area to the temporary pump station and ultimately through the new 24-inch diameter force main and into the sewer main 1000' +/- north of Yosemite Avenue. The system will be designed and constructed in conformance with City of Manteca standards for materials and installation. The Master Sewer Plan for Union Ranch is included herein as figure F.2.2 Master Sewer Plan.

### F.3 Storm Drain Master Plan

The City of Manteca currently provides storm drainage via a system of gravity storm drain lines which terminate at detention or retention facilities. Existing detention facilities discharge into a network of open channel and underground pipes owned and maintained by the South San Joaquin Irrigation District (SSJID). SSJID facilities eventually drain into the French Camp Outlet Canal. Several of the aforementioned open channels and underground pipes owned by the SSJID bisect the Union Ranch project area. Some will need to be relocated and/or improved in order to construct the Union Ranch project and provide for terminal storm drainage. The existing drainage diagram is included herein as figure F.3.1 Existing Drainage information.

Union Ranch will provide storm drainage via four separate collection systems which will terminate respectively at four separate detention basins. The collection systems and basins have been sized to collect storm runoff from a 10-year, 48-hour storm event. Each basin will empty into the nearest SSJID drain. Basins 1, 2, 3, and 4 will discharge into SSJID Drain 3A, Lateral RGC, Lateral DD, and Drain 3, respectively. Storm water discharge from the detention basins will be by pump stations. The storm drain basins and system extension will be sized

to accommodate storm drainage from properties at the northwest (26 +/-acres) and northeast (21+/-acres) corners of Union Road and Lathrop Road.

Per the City of Manteca Standards, the storm drain basins have been designed with the following criteria:

1. Each basin provides storage for one 10-year storm over its respective tributary area.
2. Side slopes will not be steeper than 8:1. The maximum basin side slope criteria is under review by the City of Manteca Parks & Recreation Department. The criteria may be revised to allow steeper side slopes if it is determined that they can be safely mowed by City Parks & Recreation staff.

#### STORM DRAIN BASIN VOLUME CALCULATIONS

#### REFERENCES:

1. City of Manteca Standard Plans and Specifications
2. City of Manteca Interim Percolation Basin Standards

$V = CAR/12$ , where

$$C = 0.30$$

A = area, acres

$$R = 3.56 \text{ inches}$$

BASIN NO. 1:

$$A = 151.9 \text{ acres}$$

$$V = (0.30)(151.9 \text{ acres})(3.56") / (12" / \text{ft}) = 13.5 \text{ acre-feet}$$

BASIN NO. 2:

$$A = 145.7 \text{ acres}$$

$$V = (0.30)(145.7 \text{ acres})(3.56") / (12" / \text{ft}) = 13.0 \text{ acre-feet}$$

BASIN NO. 3:

$$A = 106.9 \text{ acres}$$

$$V = (0.30)(106.9 \text{ acres})(3.56") / (12" / \text{ft}) = 9.5 \text{ acre-feet}$$

BASIN NO. 4:

$$A = 97.6 \text{ acres}$$

$$V = (0.30)(97.6 \text{ acres})(3.56") / (12" / \text{ft}) = 8.6 \text{ acre-feet}$$

**THOMPSON-HYSELL ENGINEERS**  
A DIVISION OF THE KETHI COMPANIES, INC.  
1016 12TH STREET, SACRAMENTO, CA 95834  
(916) 521-8886 FAX (916) 521-0045

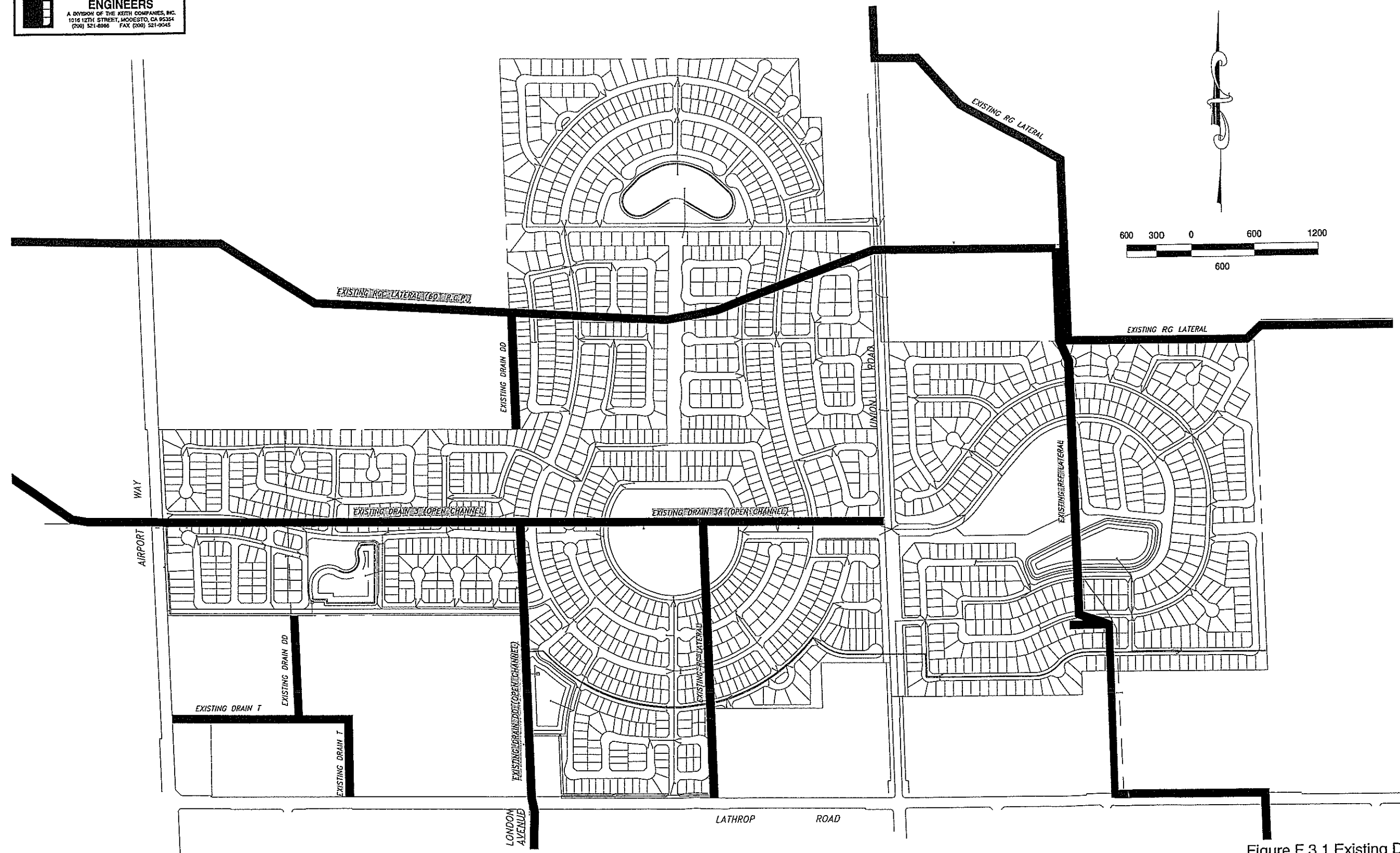

Figure F.3.1 Existing Drainage



STORM DRAIN BASIN SUMMARY			
BASIN NO.	TRIBUTARY AREA	REQUIRED STORAGE	PROVIDED STORAGE
1	151.9 ACRES	13.5 AC-FT	13.9 AC-FT
2	145.7 ACRES	13.0 AC-FT	13.0 AC-FT
3	106.9 ACRES	9.5 AC-FT	9.5 AC-FT
4	97.6 ACRES	8.6 AC-FT	8.9 AC-FT

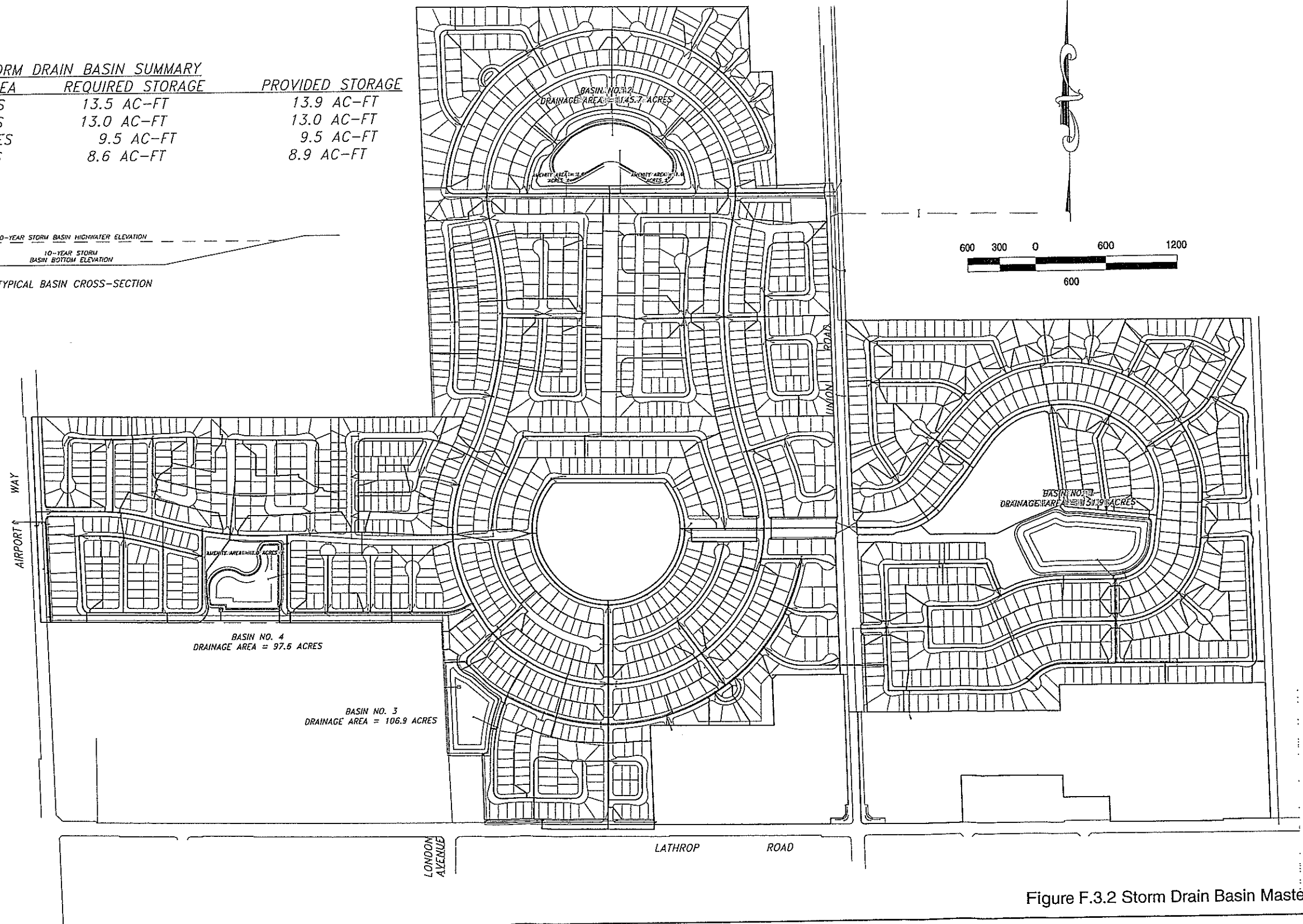
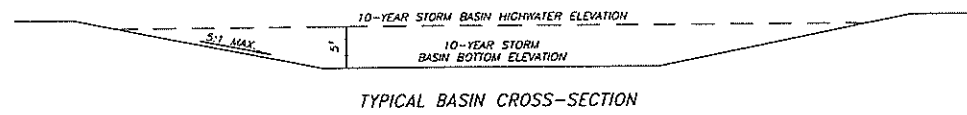

Figure F.3.2 Storm Drain Basin Masterplan

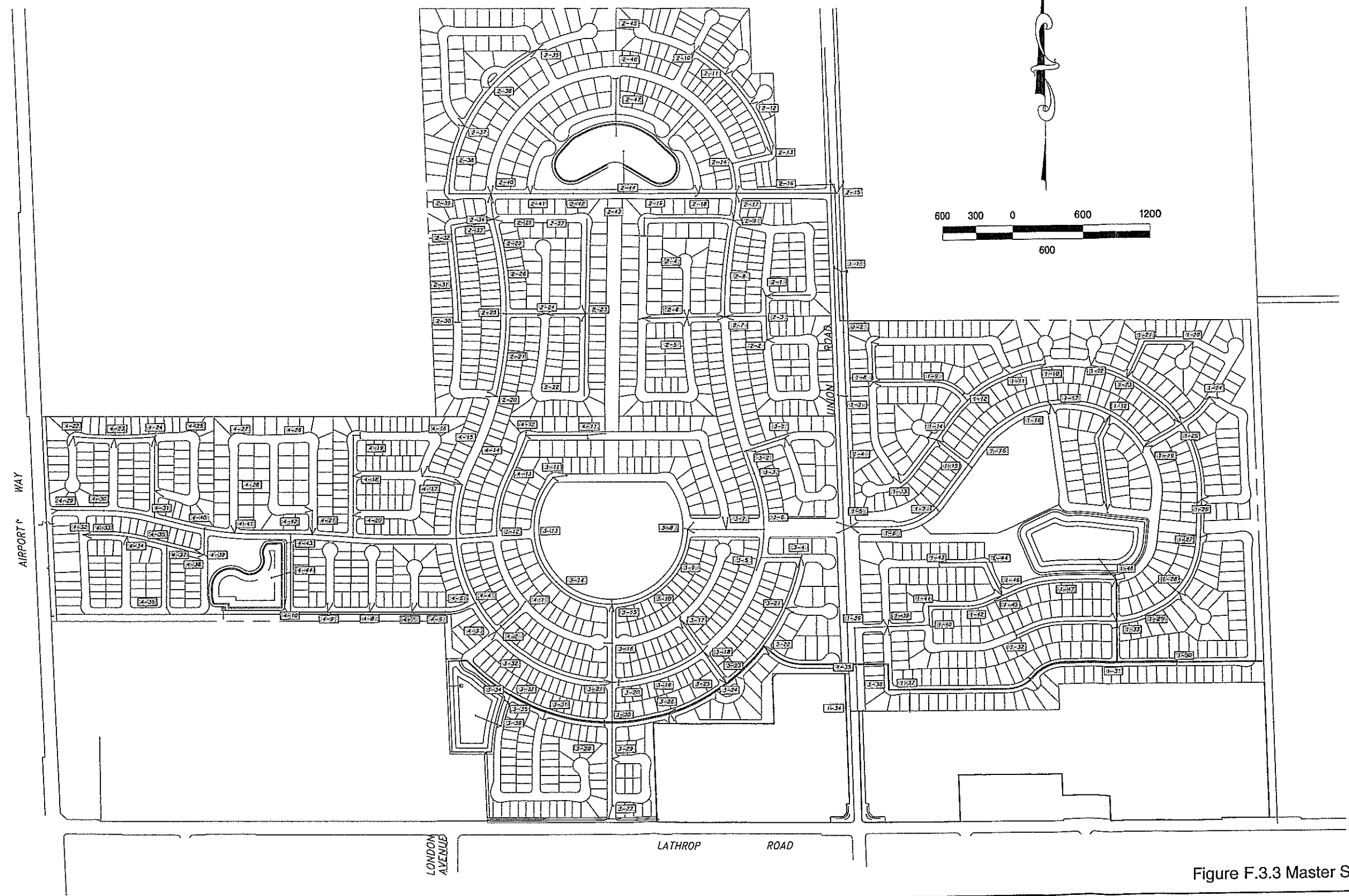
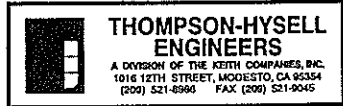

Figure F.3.3 Master Storm Drain Plan

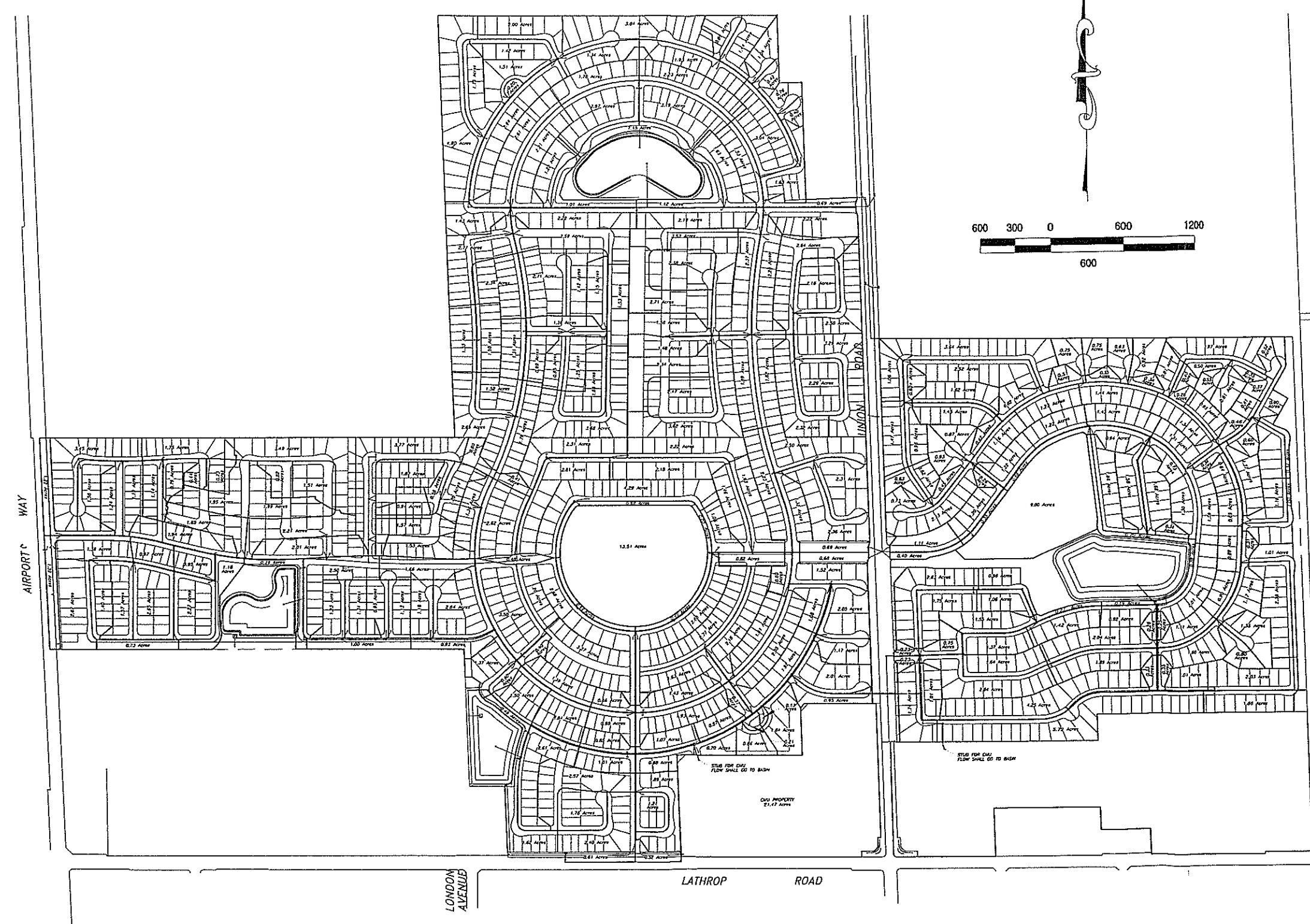
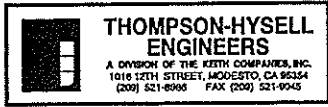

Figure F.3.4 Master Storm Drain Plan

The Union Ranch project storm drain collection system will be developed in phases throughout the site. The storm collection system for each phase will discharge into the detention pond within its respective tributary area. The Storm Drain Master Plan collection and detention system has been designed in conformance with City of Manteca standards. The detention basins will be landscaped and grass-lined and have been designed to include recreation features for use during the dry months. Play fields and walking paths are some of the amenities that can be found within each detention basin site.

The Storm Drain Master Plan includes water quality features designed in conformance with the standards of the Regional Water Quality Control Board for the Central Valley Region, the City of Manteca, and the SSJID. Storm water regulations for construction projects using Best Management Practices have been incorporated into the master plan. Discharge flow rates from each detention basin into the adjacent storm drain facilities have been designed in conformance with the requirements of the City of Manteca and SSJID. SSJID Drain 3 will be an underground pipe or box culvert system relocated to the southwest boundary of the project site. This underground system will receive and convey detained and treated runoff off site to the existing SSJID system of canals. The master storm drain plan for Union Ranch is included herein as figure F.3.3 and figure F.3.4.

#### F.4 Telephone

Telephone service will be provided to Union Ranch by Verizon Communications. Verizon currently owns and operates a telephone service network throughout the City of Manteca and will augment its existing facilities in the project vicinity and extend service into the project in order to serve Union Ranch..

#### F.5 Electricity

Electricity will be provided to Union Ranch by Pacific Gas and Electric. Pacific Gas and Electric currently owns and operates an electric service network throughout the City of Manteca and will augment its existing facilities in the project vicinity and extend service into the project in order to serve Union Ranch.

#### F.6 Natural Gas

Natural gas will be provided to Union Ranch by Pacific Gas and Electric. Pacific Gas and Electric currently owns and operates a natural gas service network throughout the City of Manteca and will augment its existing facilities in the project vicinity and extend service into the project in order to serve Union Ranch..

#### F.7 Cable Television

Cable Television will be provided to Union Ranch by Comcast. Comcast currently owns and operates a cable television network throughout the City of Manteca and will augment its existing facilities in the project vicinity and extend service into the project in order to serve Union Ranch.

---

## Section G. Resource Planning

### Natural and Cultural Resources

#### G.1 Biological Resources

The plan area is located on level terrain, which has been dominated by agricultural activity on the rural outskirts of the city of Manteca. A Biological Resources Constraints Analysis was prepared for the portion of the project area west of Union Road by Monk & Associates September 2003. An EDAW biologist conducted a general overview of the remainder of the project area on December 4, 2003. This section of the Specific Plan has been prepared based on those findings.

##### G 1.1 Wetlands

The project site has several agricultural irrigation ditches and is adjacent to an abandoned irrigation ditch on the east. While the agricultural ditches exhibit wetland characteristics, they only circulate pumped irrigation water. The only hydrological connection is to underground irrigation district pipes. These ditches were excavated in dry ground, and/or do not otherwise constitute straightened or channelized natural drainage ways. Based on these circumstances it is unlikely that the irrigation ditches would be considered Waters of the U.S. However, only USACE can make that determination and a Wetland Delineation would need to be conducted and approved by USACE as part of the project permitting process.

The abandoned irrigation ditch adjacent to the eastern project boundary supports riparian habitat, which is considered sensitive habitat by the California Department of Fish and Game (DFG) and is protected under Section 1602 of the Fish and Game Code. The potential need for protection buffers will be determined through the environmental review process.

##### G 1.2 Terrestrial Biology

###### San Joaquin County Multi-Species Habitat Conservation and Open Space Plan (SJMSCP)

The SJMSCP provides a strategy for balancing the desires to conserve open space in San Joaquin County, maintain the agricultural economy, and allow development. It was developed to avoid, minimize, and mitigate impacts on plant and wildlife habitat. Participation in the SJMSCP is voluntary for local jurisdictions and project proponents. This project would be eligible to participate in the SJMSCP. The San Joaquin Council of Governments (SJCOG) maps the area occupied by the project site as agricultural and open space. Under Section 5.3.1 of the SJMSCP, a fee of \$1,724 per acre would be paid by the applicant for the conversion of this category of land into residential development. This fee would fund most of the necessary mitigation for impacts to special-status species covered by the SJMSCP. The project applicant is committed to participating in SJMSCP and contributing the applicable fees under the SJMSCP.

## Special-Status Species

### Plants

Suitable habitat has been identified for special-status plant species that could potentially occur in the riparian areas onsite. These include Sanford's arrowhead, slough thistle, and rose-mallow. None of these species is state or federally listed as threatened or endangered. These three special-status plants are covered under the SJMSCP.

### Wildlife

Based on the initial biological constraints analysis prepared by Monk & Associates (2003) for the western portion of the project area, suitable habitat for some special-status animals was identified. These include burrowing owl, Swainson's hawk, and other raptors.

#### Burrowing Owl

According to Monk & Associates (2003), no burrowing owls were observed during their site investigation, although there are numerous records of the animals in the vicinity of the project site and the California Department of Fish and Game (CDFG) would consider the project site to provide suitable habitat. This species is covered by the SJMSCP. Additional mitigation may be required if any owls could be taken directly by the project.

#### Swainson's hawk

The Swainson's hawk is state listed as a threatened species. Foraging habitat for this species is present on and adjacent to the site. The site also provides a few trees on the east side of Union Road that are considered low quality nesting sites for Swainson's hawk. There are numerous nesting records for this species in the project vicinity and Swainson's hawks were observed flying over the site during a biological survey conducted in August 2003 (Monk and Associates 2003).

Participation in the SJMSCP would mitigate impacts associated with the loss of foraging habitat for the Swainson's hawk. Additional mitigation may be needed to avoid direct take of any species' nest on the site.

#### Other Raptors

All raptors are protected under §3503.5 of the California Fish and Game Code, which prohibits the take or destruction of raptors, including their nests and eggs. Raptors that occur or could occur on the project site include northern harrier, white-tailed kite, and red-tailed hawk. The SJMSCP provides coverage for northern harrier and white tailed kite. The site provides marginally suitable foraging and nesting habitat for the raptors listed above. If direct take of any of these species may occur, additional mitigation could be required.

### G 1.3 Biological Resource Guidelines and Standards

The Specific Plan will remain consistent with the applicable Manteca General Plan (MGP) policies as listed above in Section G.1 Biological Resources. The project proponent will ensure the implementation of the MGP policies for the protection of biological resources. The project proponent will participate in the avoidance, minimization, and mitigation measures developed

for special-status species in accordance with the California Fish and Game Code and those of the SJMSCP. Additionally, a Mitigation Monitoring and Reporting Program will be prepared to ensure that any mitigation measures applicable to the protection of biological resources developed during the environmental review process will be implemented during the design and construction phases as appropriate for this project.

## G.2 Water Quality

Water quality will be protected from the effects of contaminated urban runoff into streams, channels, and natural drainages. The Environmental Protection Agency administers the National Pollutant and Discharge Elimination System (NPDES) Program, which requires permitting for construction to protect water quality. As part of the permitting procedure a Storm Water Pollution Prevention Plan would be developed for construction activities.

### G.2.1 Water Quality Resource Guidelines and Standards

The NPDES requirements and the implementation of Best Management Practices (BMPs) will be applied to the Specific Plan area and shall be required to minimize pollutant runoff. The project applicant is committed to the implementation of BMPs consistent with the City of Manteca's standards and ordinances and as outlined in the City's Storm Drain Master Plan. The Specific Plan will remain consistent with the applicable Manteca General Plan policies as listed above in Section C3.5d Water Quality and implementation of those policies for the protection of water quality. A Mitigation Monitoring and Reporting Program will be prepared to ensure that any mitigation measures applicable to the protection of biological resources as developed during the environmental review process are implemented as part of the project design and construction policies.

### G.2.2 Proposed Lake Uses

The proposed lakes will be the focal point of the Active Adult Community Recreation Center. The lake will serve as the back drop to the main project entry. The water surface at the south portion of the lake will be approximately 2 feet and a recirculated waterfall is proposed downstream of the bridge crossing. There are several wooden structures adjacent to or within the lake limits. These structures provide additional view and access points for the residents to enjoy the lake.

### G.2.3. Lake Physical Characteristics and Irrigation Reservoir

The lakes have a surface area of 2.2 acres. The average depth of the lakes is approximately eight feet with a maximum depth of fifteen feet. The lake shoreline is approximately 1,800 linear feet. The lake volume is 17.5 acre-feet or 5.6 million gallons.

The lake may be used as a reservoir for irrigation water. The lake recirculation pump station will include irrigation pumps, filters and controls to irrigate the  $\pm$  4 acres of landscape area within the entire community recreation center park. This use of the lake as an irrigation reservoir will prevent minerals from accumulating in the lake water as a result of evaporation. Using the lake as an irrigation reservoir not only provides water quality enhancement, but it also collects stormwater and nuisance water runoff from the recreation center area will be collected, treated and reused within the lake to make-up evaporation and irrigation. The lake will be lined with clay or a suitable geomembrane such as P.V.C. or H.D.P.E.

The average annual evaporation rate is 50 inches per year. That equates to an average of approximately 8,200 gallons per day (total of 50,000 GPD for irrigation and lake evaporation). From a water usage standpoint, the lake will require less water than recreational turf landscape area of similar size.

The makeup water due to evaporation and irrigation will be from on-site wells. The flowrate required is less than 50 gallons per minute to make up for daily evaporation. The additional flowrate required from the wells for makeup water due to irrigation will need to be determined.

#### G.2.4 Lake Water Quality Management System(s) and Vector Control Plan

##### Aeration

In order to minimize potential reduction in lake water dissolved oxygen concentrations and to promote vertical water circulation an aeration system will be utilized. The aeration systems will add dissolved oxygen into the water directly via mass transfer from air bubbles into the lake water. Aeration systems also transport water from the lake bottom to the top using the surface tension of the air bubbles to bring water to the surface where it can then absorb the oxygen from the atmosphere.

##### Water Replacement

Due to the continual and daily nutrient loading occurring in lakes (from various sources including birds, landscaping, urban runoff, etc.) and the subsequent difficulty in maintaining low concentrations of nutrients which contribute to poor water quality, irrigation water will be taken out of the lakes to be replaced with makeup water with higher water quality.

##### Water Circulation

Recirculation is used in conjunction with the other methods described above to improve water quality by enriching oxygen-deficient areas and increasing mass transfer of constituents to oxygen-rich areas of the lake.

##### Lake Nutrient Removal

Biological filters (or biofilters) will be designed as the primary lake water quality nutrient removal system for this project. Biofilters typically designed for lake water quality enhancement are comprised of gravel bed in which water is pumped through. The gravel provides an ideal attached-growth media for a biological mass which resides on the gravel and removes the nutrients as the water is pumped through the gravel bed.

##### Vector Control

Mosquitoes, midges, and other vectors will be controlled through physical and chemical means. The lake water system will be designed with physical characteristics to minimize the habitat for propagation of mosquito larvae (by eliminating stagnant water surfaces and allowing the sun and wind to contact the open water surface, it is impossible for mosquito larvae to survive). In addition, habitat will be provided for predator species to control vectors. Lake operations and management personnel are trained to contact County Vector Control and apply the appropriate chemicals as necessary.

### G.2.5 Lake Access and Public Safety

Residents and visitors will be notified that wading and swimming is not allowed. However in the event that someone ends up in the lake, the shoreline as designed will provide safe access out of the lake. A concrete safety shelf will be designed at the edge of the lake. If someone falls into the lakes, they will only be in 18" of water. The interior slope of the lake gradually goes down to the middle of the lake at a four to one slope (4 Horizontal: 1 Vertical). At the end of the shelf, individuals would be swimming instead of walking along the bottom of the lake.

### G.2.6 Operations and Maintenance (O&M) Program

The following maintenance activities will be part of the lake O&M program:

#### Debris Removal

The servicing technician should physically remove any floating or shoreline debris from the lakes. Any larger branches from trees in the water or other debris too far from the shore should be removed with the use of a service boat. All debris should be bagged and placed in a designated dumpster on site.

#### Algae Control

If uncontrolled algae growth is observed it should be treated with the use of algaecides directly on the filamentous algae along the shorelines or sprayed on the lake surface for planktonic algae. A water colorant, Aquashade, may be applied on an as needed basis to minimize the growth of algae and aquatic weeds by reducing the ultraviolet light penetration.

#### Aquatic Weed Control

Aquatic weed growth may occur in the lakes. The weeds may be allowed to flourish until they come within six inches of the water surface or eight feet from the shoreline. At this time, mitigation procedures should be employed. To remove the unwanted vegetation, chemicals may be applied to reduce the re-growth potentials.

#### Pump Maintenance

All pumps should be inspected monthly. A maintenance log should be located in the pump house and each maintenance visit should be noted in the log. The technician should automatically perform all annual and semi-annual maintenance.

#### Biofilter Maintenance

The biofilter(s) should be backwashed and the media gravel rotated every six months.

#### Aeration System Maintenance

The aeration system pumps should be inspected each month. Necessary routine maintenance should be performed at that time. Aeration pumps with air filters should have the air filters cleaned monthly or more frequently as needed. Aeration disks should be inspected annually.

---

### G.2.7 Lake System – Water Quality Management Program

Providing the storm water treatment function as part of an aquascape relies on recreating a natural ecosystem that can utilize biologic processes for treatment of urban pollutants in runoff as well as maintaining the normal health of the aquascape system. The primary elements that have been integrated into this unique type of treatment aquascape system include: (1) wetlands planters, (2) lake biofilter beds, (3) pretreatment wetland filters, (4) aeration, and (5) storm water retention volume/capacity, when successfully applied can achieve exceptional water quality results.

Lake biofilters consist of separate self-contained submerged gravel beds adjacent to the perimeter of the lake through which lake water is circulated and distributed underneath through a slotted pipe system. A naturally occurring biological mass (microorganisms) will coat the gravel and serve to strip the water passing through the filter of nutrients (nitrogen, phosphorous) that would otherwise promote algae growth. In addition, the recirculation pumping reintroduces oxygen into the lake system and increasing the overall dissolved oxygen content. The combination of limited food supply and aerobic conditions reduce the potential for lake eutrophication. A critical feature that needs to be incorporated in the biofilter design to ensure long term performance is the ability to effectively perform periodic backwashing in order to remove material that accumulates within filter voids and prevents adequate filtration. Simply reversing the direction of flow through the biofilter piping system is not sufficient to distribute flow and a separate backwash system should be used. Another important design aspect of the biofilters is the layout and location of these features in order to promote the maximum water quality benefit. Generally placement is recommended at terminal ends of the lake geometry which enhances the overall lake water circulation. The biofilters are generally designed so that the velocity does not exceed 0.5 gpm per square foot of biofilter, assuming minimum 24-inch thick gravel filter. The amount of biofilter needed to treat the lake system depends upon the amount of turnover or lake recirculation time for treatment, where industry averages for lake turnover rates without biofiltration range from 5 to 15 days.

A stabilized biological lake system requires maintenance of the dissolved oxygen levels which will eliminate the potential for odor problems and other lake operating issues. Maintaining the necessary dissolved oxygen levels is achieved through the application of a fine bubble diffusion system placed along the bottom of the constructed lake. Additional benefits of aeration include destratification of the lake's water column to reduce surface water temperature and enhancing the natural vertical movement or circulation patterns. The aeration utilizes low-pressure and sized to provide turn over every 3 to four hours. The ability to develop extremely fine bubbles can be achieved through the use of aeration disk pods constructed with a flexible rubber skin that precisely controls the size of the bubbles. The importance of the fine bubbles compared to the large bubbles from a simple perforated pipe system involves the increased contact area provided by the fine bubbles enhancing oxygen transfer. The size of the bubbler system is typically based upon the shape or geometry of the constructed lake as compared to the size; in order eliminate any dead zones. The movement of lake surface water from wind and other water feature elements such as waterfalls or fountains can provide additional aeration.

Separate wetland planters periodically located along the perimeter of the lake edge will assist in promoting the overall water quality objective for the lake system. The wetland planters can be constructed along shelves in the lake shoreline with walls separating the lake except for the crest to allow for submergence from the lake water level. The wetlands function to filter out waste from the lake water through various natural chemical and biological processes. Methods to determine the amount of wetland area required for treatment involve correlations related to the concentration or amount of nutrients in the lake water.

The normal lake operating water levels would have the ability to "retain" or store the design "storm water quality volume" as defined in the City of Manteca Stormwater Quality Manual.

### G.3 Cultural Resources

The project area is located in a portion of the Central Valley fed by the San Joaquin River approximately 4 miles to the southwest, the Stanislaus River approximately 9.5 miles to the southeast, and several creeks and sloughs approximately 3-4 miles to the north and northeast. With plentiful resources and temperate climate, the Central Valley was well populated prehistorically and served as the location for some of the more substantial village sites known in California. Additionally, according to ethnographic accounts, the project area is located in an area, which was considered the territory of Northern Valley Yokuts during early Spanish exploration into northern California. The project area is flat terrain and is privately owned and occupied by farmsteads, orchards, and miscellaneous outbuildings associated with the agricultural use of the area. The City of Manteca was incorporated in 1918 during a period of growth in California and an expanding agricultural base. Some of the buildings and structures located in the project area could be considered historic resources.

A number of federal, state, and local regulations, statutes, and ordinances protect cultural resources in California. Management of cultural resources in the state is guided in large part by the National Historic Preservation Act (NHPA) of 1966 and the provisions of the California Environmental Quality Act (CEQA).

Although the treatment of cultural resources on this project is guided primarily by the provisions of CEQA, federal permitting would require compliance with Section 106 of the National Historic Preservation Act (NHPA).

#### G.3.1 Regulatory Framework and Thresholds

##### *Federal*

##### *National Historic Preservation Act*

Section 106 of the National Historic Preservation Act (NHPA) requires that federal agencies take into account the effects of their actions on properties that may be eligible for listing or are listed on the NRHP, and afford the ACHP a reasonable opportunity to comment. To determine whether an undertaking could affect NRHP-eligible properties, all cultural sites that could be affected must be inventoried and evaluated for inclusion on the NRHP.

*Native American Graves Protection and Repatriation Act*

Native American human remains are protected under the Native American Graves Protection and Repatriation Act (NAGPRA) of 1990 (25 United States Code [USC] 3001 et seq.), which requires federal agencies and certain recipients of federal funds to document Native American human remains and cultural items in their collections, notify Native American groups of their holdings, and provide an opportunity for repatriation of these materials. This act also requires plans for dealing with potential future collections of Native American human remains and associated funerary objects, sacred objects, and objects of cultural patrimony that might be uncovered as a result of development projects overseen or funded by the federal government. Native American human remains also are protected under CEQA, as described below.

*State of California**California Environmental Quality Act*

CEQA has a much more broad and far-reaching environmental regulatory framework than the NHPA, but it also includes cultural resources as an important component of its oversight and management policies. Before discretionary projects are approved, the potential for significant impacts of the project on archaeological and historical resources must be considered under CEQA (§21083.2, §21084.1) and the State CEQA Guidelines (Title 14, §15064.5).

### G.3.2 Cultural Resource Standards and Guidelines

The Specific Plan will remain consistent with the applicable Manteca General Plan policies and implementation of those policies for the protection of cultural resources. The project proponent will adhere to the guidelines and policies provided by CEQA, and if applicable, the NHPA and NAGPRA for the protection and preservation of historical and archaeological resources. A Mitigation Monitoring and Reporting Program will be prepared to ensure that any mitigation measures applicable to the protection of cultural resources as developed during the environmental review process are implemented as part of the project design and construction methods.

## Section H. Phasing and Financing

### H.1 Development Agreement

A Development Agreement will be entered into between the City of Manteca and the developers. The agreement will be executed simultaneously with the adoption of this Specific Plan. Such agreement would assure the developers the land uses and provisions specified in the Plan in exchange for providing the City of Manteca with the benefits identified in the agreement.

### H.2 Phasing of Improvements

The installation of the infrastructure necessary to serve the Specific Plan will occur in phases. The envisioned phasing of the project is illustrated in the Phasing Exhibit. The improvements needed for development of the individual phases, for the project overall as well as the East and West portions, shall be those site improvements within the area of each identified phase.

#### PHASE 1 - OVERALL

1. Union Road Improvements: Lathrop Road intersection to approximately 2650± feet north of Lathrop Road (Partial PFIP)
2. Water Well: SSJID Water Tank Location (PFIP) - Initiate
3. Project Entry Landscape and Monumentation: Intersection of Union Road at Lathrop Road
4. Traffic Signal Modification: Union Road and Lathrop Road intersection, including turn lanes (PFIP)
5. Traffic Signal Installation: Union Road at Project Entry
6. Airport Way Improvements: Approximately 1350± feet adjacent to Woodbridge project (Partial PFIP)
7. Traffic Signal Installation: Airport Way at Woodbridge project entry
8. Off Site Sanitary Sewer Lift Station and Force Main: Airport Way – Interim
9. Storm Drain Pipe/Box Culvert Construction: Woodbridge (PFIP)
10. Relocate & Underground Existing Irrigation Drains 3 & 3A: Woodbridge (PFIP)
11. Tidewater Bike Trail: Those sections adjacent to Parks A and C, as well as the project entry at Union Ranch East

#### PHASE 1A – Woodbridge Phase 1

1. On-site Improvements: Woodbridge Phase 1 – 262 +/- lots
2. Woodbridge Recreation Center: Clubhouse, Ornamental Lake, Park, Ball Fields, Bocci Courts, Walking Paths
3. Storm Detention Basins (Park “A” and Southern Basin)
4. Underground Existing Irrigation Lateral PF
5. Park “A” Improvements

PHASE 1B – Union Ranch East Phase 1

1. On-site Improvements: Union Ranch East Phase 1 – 151 +/- lots
2. Underground Existing Irrigation Lateral RFF
3. Park “C” Improvements
4. School Site Improvements

PHASE 2 – OVERALL

1. Lathrop Road Improvements
2. Complete Water Well Construction

PHASE 2A – Woodbridge Phase 2

1. On-site Improvements: Woodbridge Phase 2 – 218 +/- lots

PHASE 2B – Union Ranch East Phase 2

1. On-site Improvements: Union Ranch East Phase 2 – 83 +/- lots

PHASE 3 – OVERALL

1. Tidewater Bike Trail: Lathrop Road north to Phase 3 boundary of Union Ranch East
2. Traffic Signal Installation: Lathrop Road at Tidewater Bike Trail Crossing

PHASE 3A – Woodbridge Phase 3

1. On-site Improvements: Woodbridge Phase 3 – 326 +/- lots

PHASE 3B – Union Ranch East Phase 3

1. On-site Improvements: Union Ranch East Phase 3 – 65 +/- lots

PHASE 4 - OVERALL

1. Union Road Improvements: Approximately 1500± feet north from previous improvement boundary to north side of Woodbridge secondary entry road
2. Offsite Sanitary Sewer Pump Station & Force Main – Long Term

PHASE 4A – Woodbridge Phase 4

1. On-site Improvements: Woodbridge Phase 4 – 319 +/- lots
2. Park “B” Improvements
3. Storm Detention Basin
4. Underground Existing Irrigation Lateral RGC & Drain DD

PHASE 4B – Union Ranch East Phase 4

1. On-site Improvements: Union Ranch East Phase 4 – 44 +/- lots

---

PHASE 5A – WOODBRIDGE PHASE 5

1. On-site Improvements: Woodbridge Phase 5 – 281 +/- lots

PHASE 5B – UNION RANCH EAST PHASE 5

1. On-site Improvements: Union Ranch East Phase 5 – 92 +/- lots
2. Tidewater Bike Trail: Phase 3 North Line to Project Boundary

PHASE 6 – UNION RANCH EAST PHASE 6

1. On-site Improvements: Union Ranch East Phase 6 – 62 +/- lots
2. Underground Existing Irrigation Lateral RG

PHASE 7 – CMU DEVELOPMENT PHASE 7 \*

1. Construct north and southbound left turn lanes including median island along Union Road at the Union Road/CMU North access intersection with traffic signal.
2. Construct eastbound left turn lane with median island along Lathrop Road at the Union Road/CMU West access intersection with traffic signal.
3. Construct eastbound left turn lane with median island along Lathrop Road at the Union Road/CMU East access intersection with traffic signal.

\*Figure H.1.1 Phasing diagram does not include traffic improvements to Union Road or Lathrop Road

## H.2.1 Description of Major Infrastructure Improvements

### A. Water Well

A well will be developed by the City of Manteca. Improvements will include the test well, drilling, well pumps, motors, electrical controls, booster pump(s), pump house, masonry walls, access drives, treatment system (if required) and landscaping. The well and well site will be developed to City of Manteca standards by the City of Manteca.

### B. Off-site Sanitary Sewer Pump Station and Force Main

An interim sanitary sewer pump station will be constructed near the intersection of Airport Way and the project entry. The force main extends southerly along Airport Way. Improvements will include pump(s), sump structure, electrical controls, plumbing, force main, site work, emergency signals and landscaping. The pump station will be in 2 phases. Phase 1 will be an interim pump, only to serve a portion of the project (1397 homes), while Phase 2 will serve the entire project and be designed to serve a larger area. The pump station and force main will be developed to City of Manteca requirements.

### C. Airport Way

Airport Way will be improved along that portion adjacent to the project. Improvements include center median with curb and gutter, sidewalks or 12-foot multi-use path, masonry wall, traffic signal, and landscaping on the east side, and a southbound travel lane and shoulder on the west.

### D. Lathrop Road

Lathrop Road will be improved in that portion adjacent to the project, tying into the existing improvements on the south side. Improvements include two additional traffic signals with left turn lanes, center median with curb and gutter, sidewalks, masonry wall, and landscaping on the north side.

### E. Union Road

Union Road will be improved for the full width from the intersection with Lathrop Road to the north boundary of the Woodbridge and Union Ranch East projects. Improvements include center median, curb and gutter, sidewalk, multi-use path, masonry wall, traffic signal modifications, as well as two additional traffic signals with left turn lanes, and landscaping.

### F. Storm Water Detention Basins

Four storm water detention basins are planned within the project. One of the basins (Park "C") is located east of Union Road and the other three (Parks "A" & "B" plus the Phase 1 southern basin) are located west of Union Road. The lake located within the Woodbridge Recreation Center is not a storm basin. Storm drain pump stations will be located at each basin. Improvements include pumps, electrical controls, plumbing, telemetry, site work and emergency signals to the City of Manteca standards, including the treatment requirements of City of Manteca Ordinance No. 1253.

### G. Class I Tidewater Bike Trail

The Class I Tidewater bike trail will traverse the project area in a north-south and east-west orientation. The pathway will be improved with a shared 12-foot multi-use path and will be fully landscaped from the Lathrop Road signal crossing to the project's western boundary signal crossing at Airport Way.

### H. Underground Existing Drains and Irrigation Laterals

The existing drains and laterals located within the site will be relocated into underground pipes, with the exception of the western portion of Drain 3, which will be relocated into an underground pipe/box culvert system. The new piping location will follow the proposed street alignments and installed in conformance with SSJID and City of Manteca standards. Each existing drain and/or lateral will be relocated concurrently with the phasing of the site development. Each new underground pipe alignment will be connected to the existing drain or lateral locations at the boundaries of the project.

I. Storm Drain Pipe/Box Culvert Construction

A new underground storm drain pipe/box culvert will be constructed along the southwestern boundary of Phase 1 (Woodbridge). The new line will replace the SSJID Drain 3 and will be constructed in conformance with SSJID and City of Manteca standards. Improvements include 45-foot wide drainage easement, multi-use trail, fencing and landscaping.

H.3 Cost of Improvements

There will be no public financing for the project improvements. The proponents will only seek reimbursement for PFIP items, as they benefit the public at large. The PFIP items for the Union Ranch Specific Plan area include the improvement of portions of Airport Way, Union Road and Lathrop Road, water well, the storm drain master line and the improved traffic signal at the intersection of Union Road and Lathrop Road. The estimated cost of all PFIP items is \$3,307,500 and may be reimbursed via fee credits and/or PFIP payments as consistent with the PFIP program.

The estimated cost of some necessary major infrastructure improvements is summarized in the table below. The improvements will be funded via private financing by the project proponents with PFIP credits and reimbursements per City of Manteca standards.

Table H.3.1 Engineer's Opinion of Probable Costs, Union Ranch Off-Site Improvements

Engineer's Opinion of Probable Costs, Union Ranch Off-Site Improvements	Totals	PFIP Credit
Airport Way (Some PFIP 1350 Lf + @ \$150+/ Lf)	\$1,060,176.00	\$202,500.00
Lathrop Road (Some PFIP 1100 Lf+ @ \$50+/ Lf)	\$837,780.00	\$55,000.00
Union Road (Some PFIP 2650+ Lf @ \$100+/Lf)	\$3,775,284.00	\$265,000.00
Sanitary Sewer Pump Station & Force Main	\$2,377,200.00	\$0.00
Water Well	\$1,200,000.00	\$1,200,000.00
Class I Bike Path, Incl. Landscaping	\$1,400,000.00	\$0.00
Storm Drain Master Line (PFIP)	\$1,525,000.00	\$1,525,000.00
Traffic Signal - Airport Way Entry	\$210,000.00	\$0.00
Traffic Signal - Lathrop & Union (PFIP)	\$60,000.00	\$60,000.00
Traffic Signal - Union Road Entry	\$180,000.00	\$0.00
Traffic Signal - Lathrop Road Bike Crossing	\$140,000.00	\$0.00
	-----	-----
Grand Total	*\$13,965,440.00	*\$3,307,500.00

*\* CMU frontage improvements, utilities and signals are not included. These improvements are the responsibility of the CMU development.*

Lathrop Road frontage improvements (including roadway, raised median, curb, gutter and utilities) for the CMU portion of the project will be installed at the same time as the other project Lathrop frontage improvements defined for the project as a whole (Phase 2).

The location of traffic signal and related roadway improvements identified in the project FEIR and Mitigation Monitoring Program as necessary to specifically serve the CMU portions of the project will be deferred to future design/installation according to exact site design and access associated with future development entitlements.

Prior to issuance of any building permits for any portion of the project, the applicant shall prepare and submit for the City's approval, an Engineer's Report establishing the costs and method of payment for the traffic signals, turn lanes and related improvements to serve the CMU component of the project as identified in the FEIR and Mitigation Monitoring Program and form an Area of Benefit encompassing the entire project area and pay the proportional cost.



Figure H.1.1 Phasing Diagram

## Section I. Implementation and Administration

### I.1 Implementation of the Plan

The implementation program for this Specific Plan contains a number of procedural and administrative elements, which includes, but is not limited to annexation; adoption of the Specific Plan; rezoning; approval of tentative subdivision mapping; approval of development agreements; environmental review and monitoring; phasing plan; the adoption of design guidelines; and the administration of on-going maintenance.

The Specific Plan is the means of ensuring that future development is consistent with the General Plan. All individual development projects, including discretionary land use entitlements, within the Plan Area will be subject to the requirements of the Specific Plan. Subsequent projects within the Plan Area (including Tentative Maps, Conditional Use Permits, Minor Discretionary Permits and Minor Administrative Approvals must be consistent with this Specific Plan and the 2023 General Plan.

Maintenance of all parks and open space within Woodbridge, as well as arterial street landscaping fronting the project boundary, will be paid for by the community's Home Owner's Association. A Lighting and Landscape Maintenance District is not required for the Woodbridge project area maintenance.

In Union Ranch East, arterial street landscaping, linear walking paths and Tidewater Trail landscaping will be maintained by a Lighting and Landscape Maintenance District. The park basin (Park C) and associated amenities constructed by the developer shall also be maintained by a lighting and landscape maintenance district.

Woodbridge and Union Ranch East will temporarily fund maintenance of landscaping adjacent to the CMU parcels, including project entry monuments at the intersection of Union Road and Lathrop Road, until the CMU parcels are developed. Woodbridge will fund landscaping on the west side via HOA. Union Ranch East will fund landscaping on the east side via Lighting and Landscape Maintenance District. Upon development, the CMU parcels will take over maintenance of landscaping along their frontage and fund it through a Lighting and Landscape Maintenance District.

### I.2 Annexation

The Union Ranch Planning Area is partially located within the Primary Urban Services Boundary. This Boundary needs to be expanded based on the 2023 General Plan and this Specific Plan. The adopted Union Ranch Specific Plan will provide the basis for the City's application to the San Joaquin County Local Agency Formation Commission (LAFCO) for annexation of the entire Planning Area. Annexation must be completed before final approval by the City of Manteca, and recording, of the first subdivision map, or land use entitlement in the unincorporated portion of the Plan Area.

### I.3 Adoption of the Specific Plan

The Union Ranch Specific Plan will be adopted by resolution by the Manteca City Council. Adoption makes the land uses and development standards of this Plan regulatory in nature.

The land use regulations for the Specific Plan are designed for implementation in conjunction with the Zoning Code of the City of Manteca. Where the Specific Plan specifies standards for particular uses, it shall be the regulatory authority. Where there are any inconsistency between the Manteca standards and the Specific Plan, the provisions of the Specific Plan shall be used to regulate development.

The Union Ranch Design Guidelines will be adopted in conjunction with the Specific Plan. The Design Guidelines provide additional criteria to guide the City of Manteca in their review of the proposed project. The Design Guidelines specify policy governing architectural treatment, site planning, landscaping, lighting and signage. The guidelines will help ensure a unified development character for the Plan area while providing flexibility and guidance for individual projects.

### I.4 Plan Review and Amendments

The Specific Plan shall be implemented through a method of Planned Development permits and site plan review and approval, which might include minor Specific Plan Amendments determined at a staff level, or Major Specific Plan Amendment requiring Planning Commission approval. A Planned Development permit is required for the commercial and multi-family land uses. Plans for the landscape and open space areas are subject to the review and approval of the Parks and Public Works Departments. Plans for the parks are to be reviewed by the Parks and Recreation Department, with final approval by the City Council.

Application for review of plans and permits shall be in the form established by the Planning Director at the time of application for the plan/permit. Plan and permit requests shall be evaluated for consistency with the adopted Specific Plan and Design Guidelines and for compatibility with adjacent projects, with emphasis being given to compatibility with other projects within the Specific Plan area. A written finding of consistency with the Specific Plan and compatibility shall be provided.

A Minor Specific Plan Amendment may be processed if it is determined by the Planning Director to be in substantial conformance with the overall intent of the Union Ranch Specific Plan, the applicable development agreements, the 2023 General Plan, or the Environmental Impact Report. Examples of possible Minor Specific Plan Amendment include, but are not limited to:

- Modifications to the Design Guidelines that do not impact the overall design intent.
- Changes to phasing boundaries that do not impact infrastructure sizing, financing districts or the provision of adequate service to existing developments, or impacts to the capacity to serve future development.

- Variations in permitted use-type and adopted development standards that do not substantially change the character of the Specific Plan.
- Minor lot adjustments and boundaries or street alignments.

If the Planning Director determines that a proposed amendment does not meet the criteria of a Minor Specific Plan Amendment a Major Specific Plan Amendment shall be processed and reviewed in the same manner as the initial Specific Plan adoption.

## Section J. Design Guidelines

### J.1 Introduction

The Union Ranch Design Guidelines have been provided within the Specific Plan document to serve as an outline for the overall theme, character and standards for development within the Planning Area. The design guidelines are assembled for the purpose of intelligently and cooperatively guiding the physical implementation of the goals and policies of the Specific Plan, as well as to create a distinctive character and quality image for both Woodbridge by Del Webb and Union Ranch East.

The guidelines provide detailed performance criteria and standards to be considered by City staff, Design Review Boards, Design Review Committees, Planning Commission, or City Council in the review of individual developments within the Plan Area. The guidelines are intended to encourage creativity in solutions to specific design opportunities. However, in order to meet the overall objectives of the Specific Plan, certain standards must be fulfilled, where the provisions of the Union Ranch Specific Plan Design Guidelines are more restrictive than the zoning ordinance the Union Ranch Specific Plan shall govern development.

The levels of development, which together, provide for the total community experience for Union Ranch, are:

- 1) Private development parcels, including acreage established for single-family residential housing and commercial mixed-use areas.
- 2) Public/Quasi-Public development parcels including acreage established for open space areas and landscape corridors, public parks and private recreation facilities.
- 3) Specialty components including lighting, signage, street furnishing, decorative paving, sound and decorative walls, street intersection treatments, vehicular entries and multi-use trails. These specialty features are the most important elements in establishing a community "signature", and as such will be dispersed throughout the Specific Plan Area.

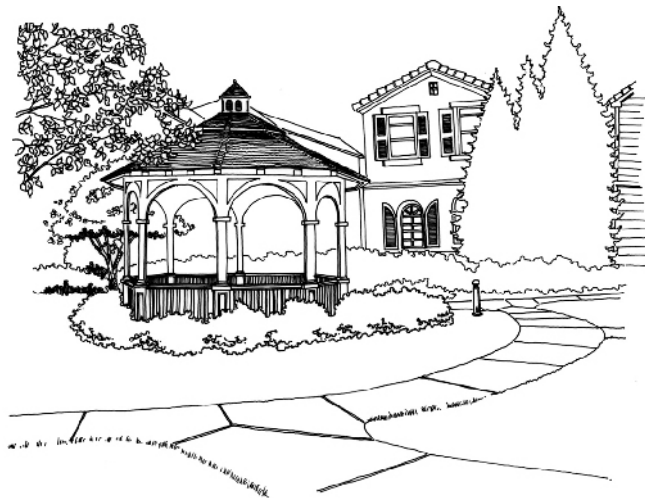

Figure J.1.1 Neighborhood Character

The Union Ranch design theme is rooted in the agricultural history of the area, with an emphasis on the traditional farming vernacular often associated with small town America. The general concept for the community elements shall borrow heavily from natural materials such as fieldstone for entry walls and pilasters, stucco in cool colors for wall faces, wood textured siding, and wood textures for arbors and fencing. An apt description of the overall design theme might be to say that the Union Ranch community design is Norman Rockwell in origin, but California in execution.

Basic elements are as follows:

- Stone, or stone veneer in cool natural colors, shall be the predominant accent material for wall accents and pilasters.
- Elements traditionally constructed of wood such as arbors, lattice screens and rail fencing shall be constructed of metal for durability and ease of maintenance. Finish colors shall be mainly lighter shades of warm greys and whites, and earthen colors to compliment the colors of the accompanying natural stone finishes.
- Stucco finishes will be employed liberally, but used as backdrops for signage on entry walls--but it may be a dominant finish for residential and commercial architecture.
- A palette of plants with an emphasis on color, texture and layered forms to add a distinctive richness to the landscape of Union Ranch.

The primary points of visual utilization of these signature design components will be within the public development parcels, open space and circulation uses. Private development parcels, through these guidelines, will support and enhance the signature of Union Ranch by employing the design features as outlined in the following pages. Proper implementation and enforcement of these guidelines will be the joint responsibility of the project proponent and the City of Manteca.

The following site development guidelines apply to all land uses. Though flexibility will be allowed, certain standards will be enforced to ensure a strong degree of continuity and quality throughout.

- 1) Plan Area access shall include community monuments and signage along with highly developed landscape corridors, which will reinforce the overall identity and image of community.
- 2) Planning Area access points shall be limited to those defined below to minimize traffic impacts, and to maximize landscape setbacks.
- 3) Landscape development setbacks will conform to the adjacent street landscape easement, with no parking facility, building, or other structure allowed in the easements.
- 4) Pedestrian circulation is encouraged throughout the Plan Area with an extensive network of multi-use paths through the landscape corridors, as well as sidewalks adjacent to all roadways. In the CMU parcels, and the private recreation center, circulation systems will be developed from parking areas to these corridors, from the parking areas to the building entries, and from one

site to another. A clear accessible path of travel will be evident within these circulation corridors.

- 5) Site furnishings will be designed to conform to site architectural elements and the material palette developed for the community. Site furnishings will be long lasting in nature. Pedestrian plazas within the CMU areas will serve to accent entries to facilities, and to provide for breaks from the work environment. All site furnishings should be simple and functional in design.
- 6) Screening requirements for storage, truck loading areas, and utility equipment such as gas meters, transformers, and backflow preventors will be screened from view from all rights-of-way, and will be minimized to all on site views via the use of landscaping or walls.

## J.2 Residential Design Guidelines

Union Ranch provides a variety of housing types within two distinct communities, Woodbridge by Del Webb and Union Ranch East, each linked thematically with common landscape based design elements. To ensure the appropriate design of these communities, architectural and landscape design guidelines are provided to promote and maintain the character of the overall Union Ranch Plan Area.

Designs may include, but are not limited to, the following project products:

- Single Family Detached Homes in Union Ranch East and Del Webb
- Apartment/Townhomes (Attached) in the CMU designated parcel

### J.2.1 Woodbridge by Del Webb Residential Design Character

The architectural and landscape design goals for Woodbridge are:

- a. The architectural theme and building form should be of an architectural character that is reminiscent of small town America, with particular emphasis placed on materials, finishes and design accents that reflect a rural estate vernacular.
- b. Natural materials, such as wood or wood-patterned siding, stone or stone veneers, masonry, and stucco are encouraged as building or accent material.
- c. The “Norman Rockwell” design theme should prevail in graphics, signing, colors, street furniture, lighting, and landscaping.
- d. The architectural design of buildings should consider the site, relationship to other structures, climatic orientation, and solar access.
- e. Buildings with long uninterrupted exterior walls should be avoided. Walls should have varied forms to create shadows to soften the architecture. Four-sided architecture is required with accent trim and articulations required on all building sides that are visible from any street or public right-of-way including trails.
- f. Roof flashing, rain gutters and downspouts, vents and other roof protrusions should be finished to match adjacent materials, colors, and textures.

- 
- g. The finish colors of general wall areas should be of natural tones or variations of these tones in cool hues. Limited accent colors of compatible schemes may be used for trim, window areas, balconies, and doors, also in cool hues rather than warm earthen or vibrant primary colors.
  - h. Strong variations of traditional architecture, massing, and forms, which create texture and shadow are encouraged.
  - i. Openings in units should be accented architecturally through indentation, framing, and roof variations.
  - j. Hip, gable, Dutch gable, and clipped gables are appropriate design elements for roofs.
  - k. Clay tile, concrete tile, and slate are appropriate roofing materials.
  - l. Dashed stucco, (not trowelled), masonry, natural stones, horizontal hardboard sidings, cedar siding, cedar shingles, and plywood board and batten are appropriate wall finish materials.
  - m. Standard side yard wing fencing for single-family detached homes will be of oversized material stained with natural finishes. Refer to details in section J.15.
  - n. Mechanical equipment shall be screened from view in all residential areas. Air conditioning or heat units shall not be visible from the street, and will not be permitted to be located on residential rooftops. In the CMU designated area rooftop units may be permitted on multi-family units if screened by parapet walls or other decorative architectural element.
  - o. Front porches and covered entries are encouraged.
  - p. The use of architectural detailing in the form of shutters, corbels, decorative lintels, and chimney tops are encouraged.
  - q. All fronts, and side yards of corner units, of all single-family residential lots will be landscaped with living plant materials upon occupancy.

#### J.2.2 Woodbridge by Del Webb Residential Design Criteria

- 1) Minimum front yard setbacks per Section C. shall be adhered to, however variations along street fronts are encouraged to provide visual interest. Building offsets should alternate a minimum of two feet along the primary house face from the minimum setback, alternating for each house in any given run of three houses or more.
- 2) All housing shall be single-story with all main entry doors facing the primary street frontage. Front entry detailing shall be a prominent feature of all house elevations.
- 3) House elevations, as made available by the builder, shall alternate with no two facades of the same style and colors to be placed side by side. In any given run of homes there shall not be more than two of the same elevation styles or two of the same color palettes within any five given run of residential units.
- 4) Residential units located on corner lots shall have installed specific corner fencing. Fencing shall return to abut the building face no less than three (5)

feet and no more than (8) eight feet from the rear corner. Fences shall not be placed in front of any window of a primary living space unless it is a bedroom or bathroom.

- 5) Corner units shall have walkways that connect directly to side streets from the primary entry walk.
- 6) At corner units side entry garages are encouraged.
- 7) Elevations shall be limited to traditional styles. Mediterranean elevations, such as Spanish Colonial, or other Italianate styles are allowed within the tradition of the California vernacular.
- 8) Building designs shall be energy efficient per the Section C.
- 9) Solar panels for an energy source are encouraged, however, they shall not be viewed from public right of ways.
- 10) Residential scale decorative lighting shall be provided on all unit fronts at garage entries and man-doors.
- 11) Roofing material is limited to cedar shake/shingle, clay tile (barrel style), and concrete/composite tile. Asphalt shingles are prohibited.



Figure J.2.1 Typical Single Family Home

### J.2.3 Union Ranch East and CMU Residential Design Character

The architectural and landscape design goals for Union Ranch are:

- a. The architectural theme and building form should be of an architectural character that is reminiscent of small town America, with particular emphasis placed on materials, finishes and design accents that reflect a rural estate vernacular.
- b. Natural materials, such as wood, stone, masonry, and stucco are encouraged as building or accent material.
- c. Buildings with long uninterrupted exterior walls should be avoided. Walls should have varied forms to create shadows to soften the architecture. Four-sided architecture is required with accent trim and articulations required on all building sides that are visible from any public right-of-way including multi-use trails.
- d. Roof flashing, rain gutters and downspouts, vents and other roof protrusions should be finished to match adjacent materials, colors, and textures.
- e. The finish colors of general wall areas should be of natural tones or variations

---

of these tones in cool hues. Limited accent colors of compatible schemes may be used for trim, window areas, balconies, and doors, also in cool hues rather than warm earthen or vibrant primary colors.

- f. Openings in units should be accented architecturally through indentation, framing and roof variations.
- g. Hip, gable, Dutch gable, and clipped gables are appropriate design elements for roofs.
- h. Clay tile, concrete tile and slate are appropriate roofing materials.
- i. Dashed stucco, (not trowelled), masonry, natural stones, horizontal hardboard sidings, cedar siding, cedar shingles, and plywood board and batten are appropriate wall finish materials.
- j. Standard side yard wing fencing for single-family detached homes will be of oversized material stained with natural finishes.
- k. Mechanical equipment shall be screened from view in all residential areas. No air conditioning or heat units shall be visible from the street.
- l. Front porches and covered entries are encouraged.
- m. The use of architectural detailing in the form of shutters, corbels, decorative lintels, and chimney tops are encouraged.
- n. All fronts, and side yards of corner units, of all single-family residential lots will be landscaped with living plant materials upon occupancy.

#### J.2.4 Union Ranch East Design Criteria

- 1) Minimum front yard setbacks per R-1 standards shall be adhered to, however variations along street fronts are required to provide visual interest. Building offsets shall alternate a minimum of two feet along the primary house face from the minimum setback, alternating for each house in any given run of three houses or more.
- 2) Front entry detailing shall be a prominent feature of all house elevations.
- 3) House elevations, as made available by the builder, shall alternate with no two facades of the same style and colors to be placed side by side. In any given run of homes there shall not be more than two of the same elevation styles or two of the same color palettes within any five given run of residential units.
- 4) Houses backing onto to Union Road shall be single-story units only and may have minimum side yard setbacks of 5 feet and 8 feet.
- 5) Residential units located on corner lots shall have installed specific corner fencing. Fencing shall return to abut the building face no less than five (5) feet and no more than eight (8) feet from the rear corner. Fences shall not be placed in front of any window of a primary living space unless it is a bedroom or bathroom.
- 6) Corner units shall have walkways that connect directly to side streets from the primary entry walk.

- 7) At corner units side entry garages are encouraged. In no case shall a garage wall front a side street.
- 8) Mediterranean elevations, such as Spanish Colonial, Tuscan or other Italianate styles are permitted within the tradition of Californian vernacular architectural styling.
- 9) Building designs shall be energy efficient per the Section C.
- 10) Solar panels for an energy source are encouraged, however, they shall not be viewed from public right of ways.
- 11) Residential scale decorative lighting shall be provided on all unit fronts at garage entries and man-doors.
- 12) Roofing material is limited to cedar shake/shingle, clay tile, and concrete/composite tile. Asphalt shingles are prohibited.

#### J.2.5 CMU Residential Design Criteria

- 1) Lighting, although designed for safety, shall appropriately shield indoor living area windows from direct glare. In public areas along walkways, in parking lots and recreational areas (non-sport) lighting will be provided to the minimum foot-candle requirement of the City of Manteca.
- 2) The materials palette described above, that reflects the design theme of the



Figure J.2.2 Typical Single Family Home

California farm vernacular is required to be used in the architectural palette. Mediterranean elevations, such as Spanish Colonial, or other Italianate styles are permitted within the vernacular styling of tradition Californian architecture.

- 3) A directory sign visible from the automobile with a turn out to view the sign shall be provided at each entry, and illuminated for nighttime viewing.
- 4) Building numbers and identification shall be in clear view and illuminated.
- 5) Landscape setbacks will be a minimum of twenty (20) feet for multi-family residential or greater to accommodate specific right of ways or greenways.

- 6) Open space will be encouraged in multi-family residential developments to reinforce the image and feeling of those being developed throughout the community. In multi-family residential zones, recreation elements such as children's play areas swimming pools, sport courts, and exercise courses should be developed, but physically and visually screened from adjacent commercial interests.
- 7) A variety of building heights should be achieved by eliminating a continuous stacking of all units in structures. Variety in height is required adjacent to right of ways but limited to a maximum of three stories.
- 8) Heating and cooling units shall be screened from view and shall not be visible from any public right-of-ways. Rooftop units are prohibited unless screened by parapet or other architectural element that is integral to the building facade.
- 9) Backflow preventors shall be screened from view using evergreen plant material.
- 10) Patio area and or balconies shall be provided for all residential units. Ground-floor units shall have a minimum of 100 square feet of outdoor spaces enclosed by a wall or wood screen with a minimum height of 4-feet.
- 11) Minimum setbacks between buildings as determined by the City of Manteca shall be adhered to at all times.
- 12) Walkways providing ADA accessibility (incl. Title 24) shall be provided between all buildings and parking areas, and all buildings and common area amenities.

### J.3 Commercial Mixed-Use Design Guidelines

The commercial Mixed Use Design Guidelines are provided to promote a multi-use project of premier quality, while harmonizing with the overall physical framework of the community. These architectural guidelines have been created to express "intent" rather than "absolutes," thereby allowing flexibility to provide design alternatives. It is paramount in a Specific Plan that architecture serves to satisfy aesthetic concerns as well as market and functional needs.

Consistency of materials ensures quality design. It is the intent of the Union Ranch Design Guidelines to provide clear directions and design criteria for users. Individual projects will be compatible with the common overall community elements; however, the need for separate identity, use of product type, or tenant preferences may dictate variations.

- a. The architectural theme and building forms should be reflective of an urban character blending with the site and be representative of the design character illustrated earlier.
- b. Building heights, signage, setbacks and other standards will be in conformance with City of Manteca standards.
- c. The architectural design of buildings should consider the site, relationship to other structures, streetscapes, and climatic orientations.
- d. Structures with long uninterrupted exterior walls should be avoided, where possible. Walls should have varied forms to create shadows and provide relief that "softens" the architecture.

- e. Natural materials such as stone, wood, granite, marble, and masonry will be encouraged. Materials such as textured or patterned concretes are compatible building accents. Stone and arbors shall be used in each architectural palette that reflects the vernacular and architectural character developed for Union Ranch.
- f. The character of commercial buildings should be compatible with adjoining structures. Buildings and structures should accentuate and promote an harmonious urban character through consistent use of materials, color, and detailing.
- g. Buildings along major arterials should provide a variety of elevations with differing setbacks and varied orientations.
- h. Openings in buildings should be accentuated architecturally through indentation and roof variations.
- i. Architectural screens, fences, and structures should be compatible in materials, color, and texture to the main building. All service areas should be screened from major streets and adjacent residential areas.
- j. Dramatic "Pedestrian Oriented" architecture will be encouraged in the shopping areas to reinforce the residential scale of adjacent housing. Building forms of simple geometry with rectangular massing will be stressed.
- k. Colonnades, arches, plazas, arcades, awnings and courtyards will be utilized to create architectural and functional excitement, and to provide shade in the summer.
- l. Massed hip and gable roofs that create a strong architectural form will be used. Concrete and clay roof tiles are acceptable coverings. Recesses and covered pedestrian walkways that create shadow and visual interest will be encouraged.
- m. Residential units are allowed in the Commercial Mixed Use designation. These units are encouraged to be obtained by the use of loft units over commercial or office ground floor units.



Figure J.3.1 Typical Multi-Family Home

### J.3.1 Commercial Parking Guidelines

Parking areas will be designed and dimensioned in accordance with the City of Manteca's zoning code as far as stall size, aisle size, and access driveways and in conformance with the Specific Plan development standards. These guidelines are designed to take the basic design guidelines and enhance them with embellishments regarding landscape treatment, coverage and use. All parking facilities will be designed to accommodate parking on site with no on street parking allowed. Parking will be visible, accessible, and easy to traverse, but will also be screened from public view. The following criteria will be observed:

- a. A screen of a minimum thirty (30) inches will be required for all parking areas. This height will be measured from the parking lot top of curb elevation adjacent the right-of-way. Screening will be accomplished by plant materials, and/or walls, land contouring, or a combination of these items. See Figure J.3.2.
- b. Plants compatible to Manteca will be utilized on this project. Trees will be selected from the Master Plant Palette found in the appendix of this document.
- c. Six (6) inch high concrete curbing will be used to protect landscape areas.
- d. A continuous eight (8) foot landscape planter will be constructed between all double bays of parking. At the end of all parking rows, a ten (10) foot wide planter will extend to within three (3) feet of the total length of the parking stall. An eight (8) foot by nine (9) foot wide planter may be substituted at the required tree spacing in commercial centers. See Figure J.3.3.
- e. All parking island planters will be planted with live landscape material and shall meet the shade requirements of the City of Manteca. Refer to the appropriate City ordinance for more information.

### J.4 Open Space Design Guidelines

The open space areas of Union Ranch include parks and a continuous greenway corridor

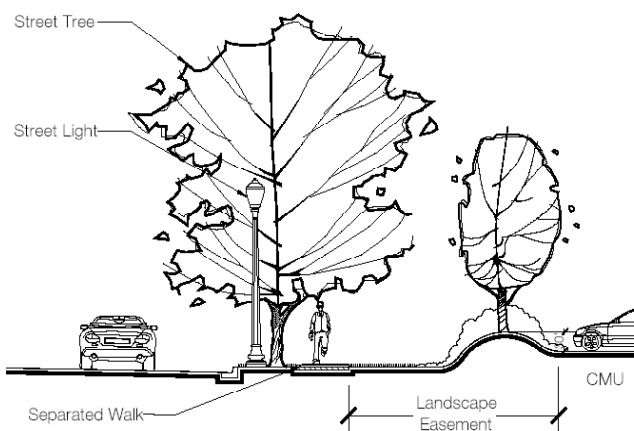

Figure J.3.2 Typical Parking Screen

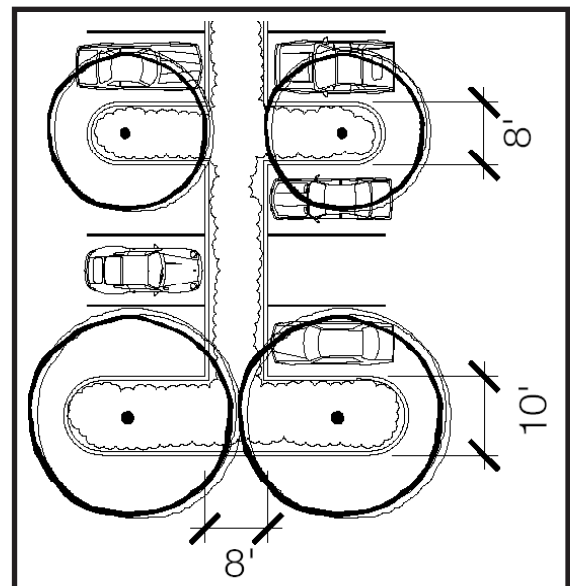

Figure J.3.3 Typical Parking Island Planter

system through Woodbridge and Union Ranch East. Landscape corridors provide the visual and physical linkage between parks and public right-of-ways.

- 1) The greenway corridors are designed to interconnect the land uses within the community. As linear extensions of the neighborhood and parks, these greenway corridors will provide passive and active recreational uses.
- 2) These greenway corridors will also include a twelve (12) foot wide multi-use pedestrian/bicycle path. These paths will not only provide for recreational uses (i.e. jogging, biking, etc.), but will also provide an alternative to vehicular travel. Thus, this circulation/open space element will link neighborhood-to-neighborhood, and residential areas to commercial and public/quasi-public centers.
- 3) Public park facilities will include various recreational use areas for all age groups, thus not only will these parks include active recreational opportunities such as basketball, but also passive recreational opportunities, such as walking and children's play areas. For more information regarding park facility design refer to Section E. Public Facilities.
- 4) Greenway corridors and public parks provide an excellent opportunity for extensive tree plantings. Plantings will be treated in informal groves to reinforce a park-like quality.
- 5) Where greenway corridors and public parks are fronted by a street right-of-way, streetscape plantings will be kept continuous. Greenway corridor and park tree plantings will be subordinate tree masses behind streetscape plantings.

### J.5 Landscape Concept

The Landscape Concept presents elements that will enhance the overall concept of Union Ranch. The intent is to develop a cohesive unit of design elements that express a theme of strength and permanence. This will be achieved by a strong delineation of street right-of-ways, corresponding landscape corridors, pedestrian/bicycle corridors, visual corridors, and gathering points. These form an overall quality, consistency, and order for all improvements and uses within the development. The design will integrate the physical elements of a developed

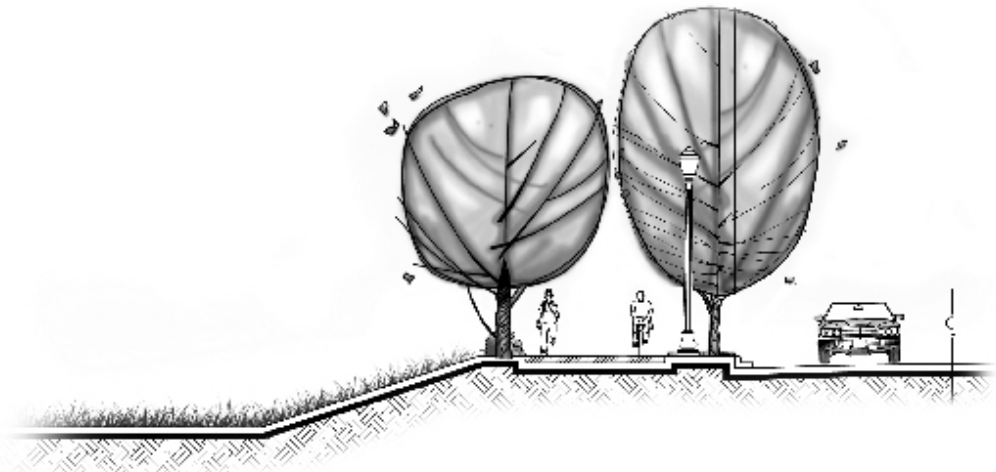

Figure J.4.1 Typical Drainage Section

---

community with the integrity of the new cohesive elements of both plant material and hardscape elements. Plant palettes in simple compositions will continually be reinforced throughout the project.

### J.6 Landscape Easements and Open Space

The overall landscape easement and open space concept is to ensure the uniformity and quality of the community. The easements will be part of the overall circulation design, as well as serve to help screen or mitigate unsightly elements such as loading areas and expansive parking facilities. Each individual easement will serve in the overall picture of the site development, from framing the external expression of the community, to identifying key entry points and areas of transition of travel within the limits of Union Ranch.

The landscape easements and open space areas are divided into various areas: streetscapes, major intersection, open space corridors, and public park/school facilities. The palette of plant materials will consist of the plants that form the landscape concept of the community.

### J.7 Streetscapes

Though each streetscape is unique within the Union Ranch community, each will be consistent in the use of landscape plantings and other streetscape elements, which clearly define the hierarchy of automobile, bicycle and pedestrian circulation. For a complete description of lane configurations and typical road sections refer to Section D. Circulation.

#### Arterial Roads

Landscape improvements along Lathrop Road, Union Road and Airport Way will have elements consistent with the general guidelines listed below, the only variation being the width of the landscape easements. The following general guidelines shall apply to these three arterials:

- 1) The ground plane material will be a mix of turf and drought tolerant groundcover, located within a varied easement width from back of curb to the soundwall at the property line.
- 2) Sidewalks shall be bifurcated at the widths indicated in Section D. Circulation. Refer to Section D. for typical street sections for each of Lathrop Road, Airport Way and Union Road.
- 3) A single row of street trees, in a single species for each arterial road, shall be planted at the back of the sidewalk or within parkway planter strip at a minimum of 30-foot on center spacing. Secondary street trees shall act as accent and shall occur in informal groupings of between three and five trees of the same species, planted between the sidewalk and the soundwall at a minimum of 200-foot intervals. Mixed massings of flowering trees and evergreen species are encouraged.
- 4) Adjacent to soundwalls shall be layered plantings of shrub massings in large groupings, layered to provided visual interest. In no cases shall a single row of a single massed species be allowed. Variety in height is required. A single row of low foreground planting may be placed in front of a single row of taller background planting. Multiple rows in multiple layers is encouraged where space is adequate. Vines shall be planted at minimum of 15-foot on-center

- spacing along all soundwalls.
- 5) Plantings in medians shall include accent trees as well as large canopy shade trees. Groundcover plantings of evergreen shrubs shall be massed. Nosings less than 3-foot in width shall receive enhanced paving of unit-pavers, or colored stamped concreted. Grouted river rock is prohibited.
  - 6) Where arterials parallel residential lots, a seven (7) foot minimum wall height will be required along rear and side yards.

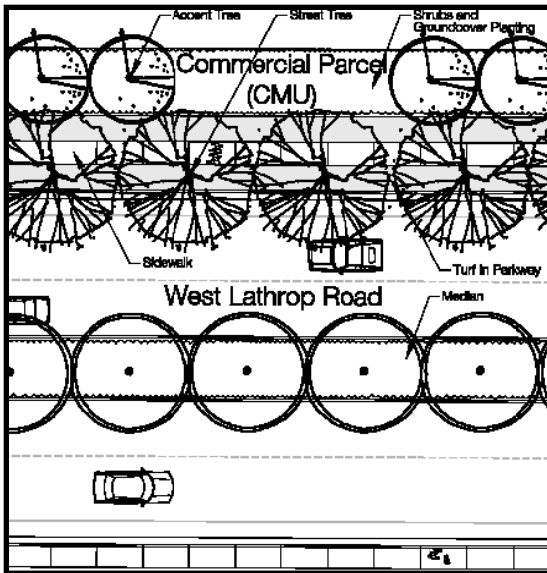

Figure J.7.1 Typical Arterial Street Section

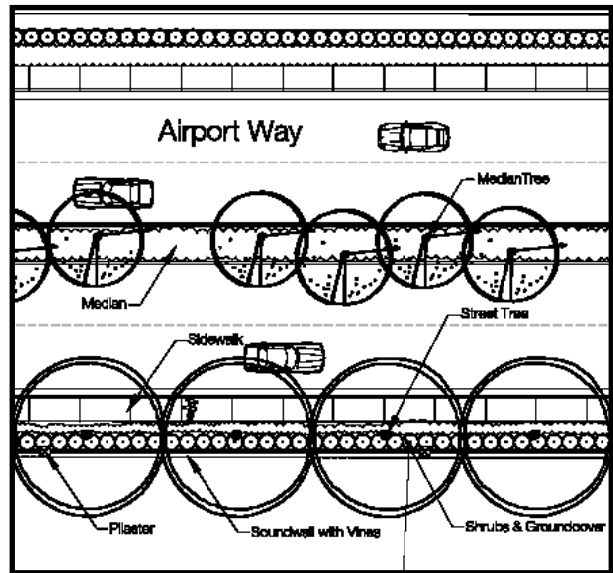

Figure J.7.2 Typical Arterial Street Section

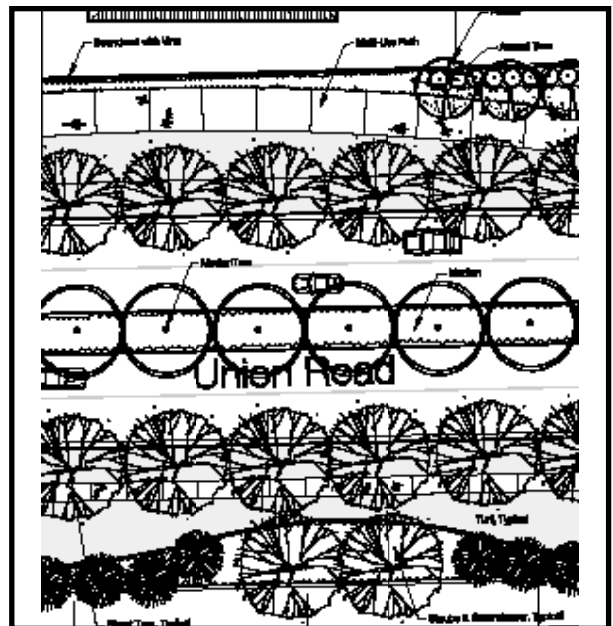

Figure J.7.3 Typical Arterial Street Section

### Residential Collectors

Landscape improvements along residential collectors will have elements consistent with the general guidelines listed below:

- 1) Residential collector streets will vary from arterial streets and residential local streets in travel lane configurations, and may contain landscaped medians.
- 2) Sidewalks shall be bifurcated at the widths indicated in Section D. Circulation.
- 3) A single row of street trees, in a single species for each arterial road, shall be planted at the back of the sidewalk or within parkway planter strip at 30-foot on center minimum spacing. Secondary street trees shall act as accent and shall occur in informal groupings of three to five trees, of the same species, planted between the sidewalk and the soundwall. Mixed massings of flowering trees and evergreen species are encouraged.
- 4) Adjacent to soundwalls shall be layered plantings of shrub massings in large groupings, layered to provided visual interest. In no cases shall a single row of a single massed species be allowed. Variety in height is required. A single row of low foreground planting may be placed in front of a single row of taller background planting. Multiple rows in multiple layers is encouraged where space is adequate. Vines shall be planted at minimum of 15-foot on-center spacing along all soundwalls.
- 5) Where collectors parallel residential lots, a seven (7) foot minimum wall will be required along rear and side yards.

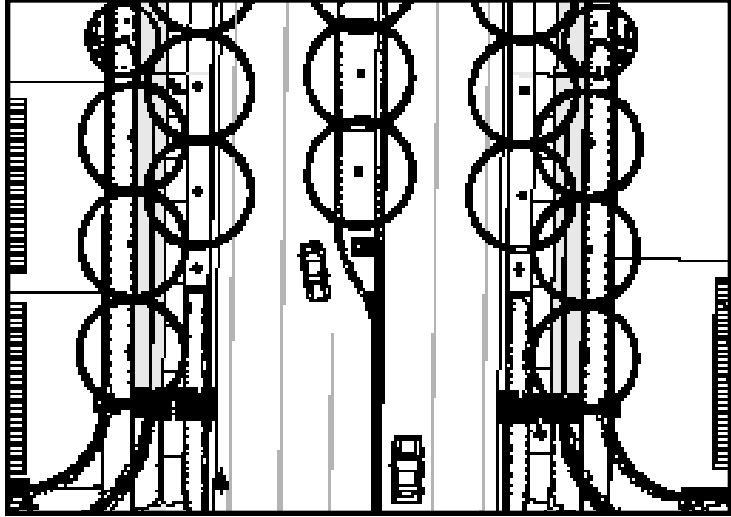

Figure J.7.4 Typical Collector Street Section

### Residential Streets

Landscape improvements along residential streets will have elements consistent with the general guidelines listed below:

- 1) Residential streets will vary from arterial and collector streets in travel lane configurations, and overall right-of-way widths. For a detailed illustration of typical residential street right-of-ways refer to Section D. Circulation.
- 2) Residential neighborhood streets will be characterized by consistent street trees, which will provide a unity of landscape character. Trees will be consistent on each street, but may vary from street to street.

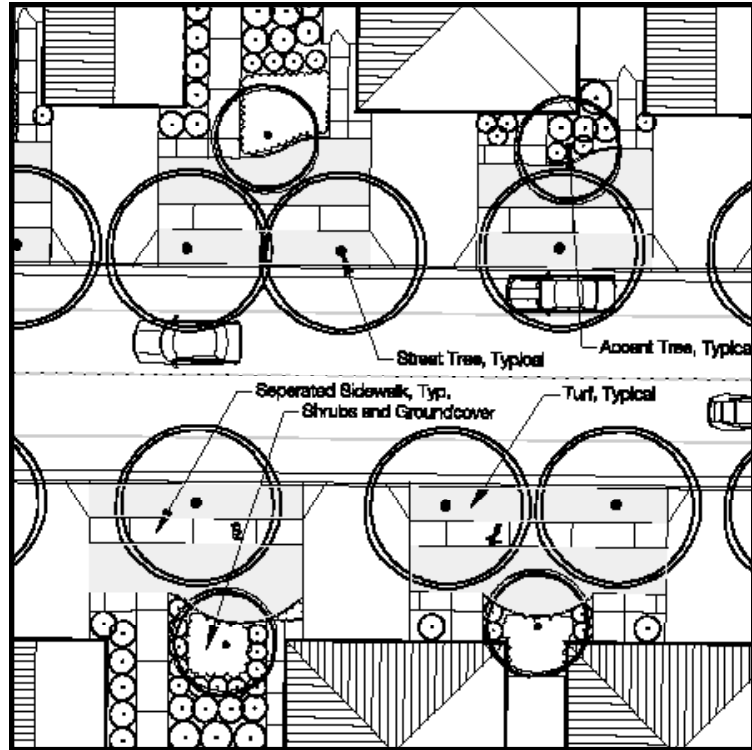

Figure J.7.5 Typical Residential Street Section

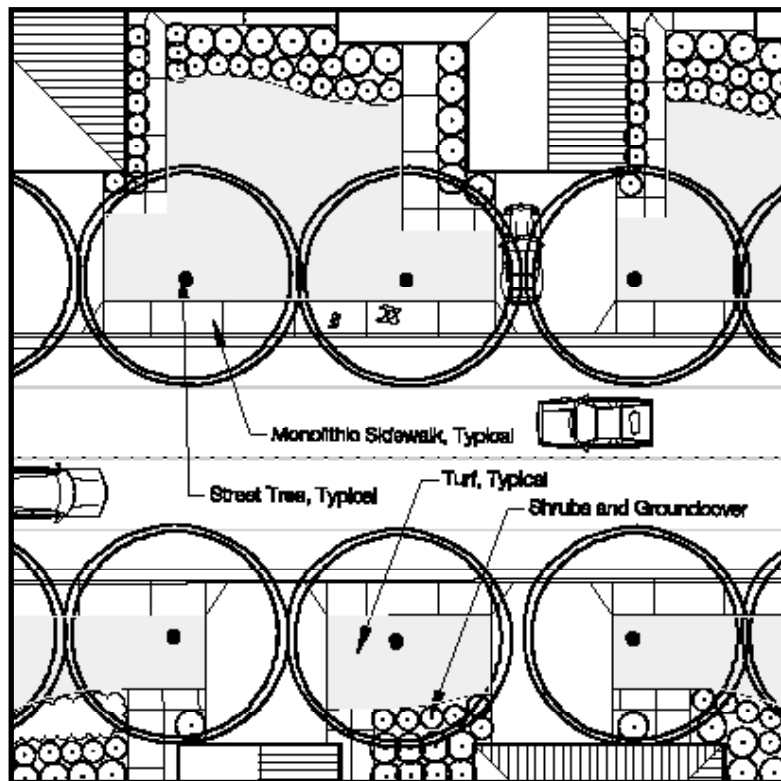

Figure J.7.6 Typical Residential Street Section

- 3) Residential streets shall have either a monolithic or bifurcated sidewalk. The width of which shall vary.

Multi-use Paths:

Landscape improvements within the greenways will have elements consistent with the general guidelines listed below:

- 1) Easement widths vary within the greenways. Typical right-of-ways within the easement shall include a 12-foot multi-use concrete path, striped for lane separation.
- 2) A knockdown bollard shall be placed wherever the path intersects public roadways.
- 3) Site furniture shall include benches and trash receptacles at nodes or intersections of pathways with other paths or public roadways.
- 4) The easement shall also include pedestrian scale lighting to a minimum of ½ foot candle with lamp deflectors placed to prevent light from shining directly into adjacent residential uses.
- 5) The easements shall be bordered by either soundwall, wood rear yard fencing, or tubular steel view fencing.
- 6) Plantings shall include shade trees placed at consistent intervals at a minimum of 60-feet on center, where space allows, groundcover planting including turf, evergreen shrub massing along walls and fences, and vines on soundwalls.

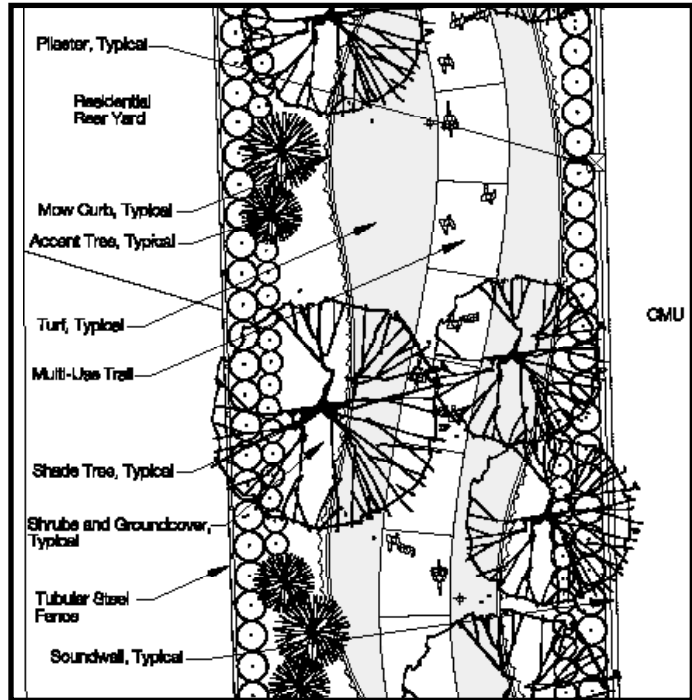

Figure J.7.7 Typical Multi-Use Path Section

## J.8 Streetscape Elements

### Entry Monuments and Gateway Elements

Uniformity and consistency of built objects and plantings is essential to ensure that the goals

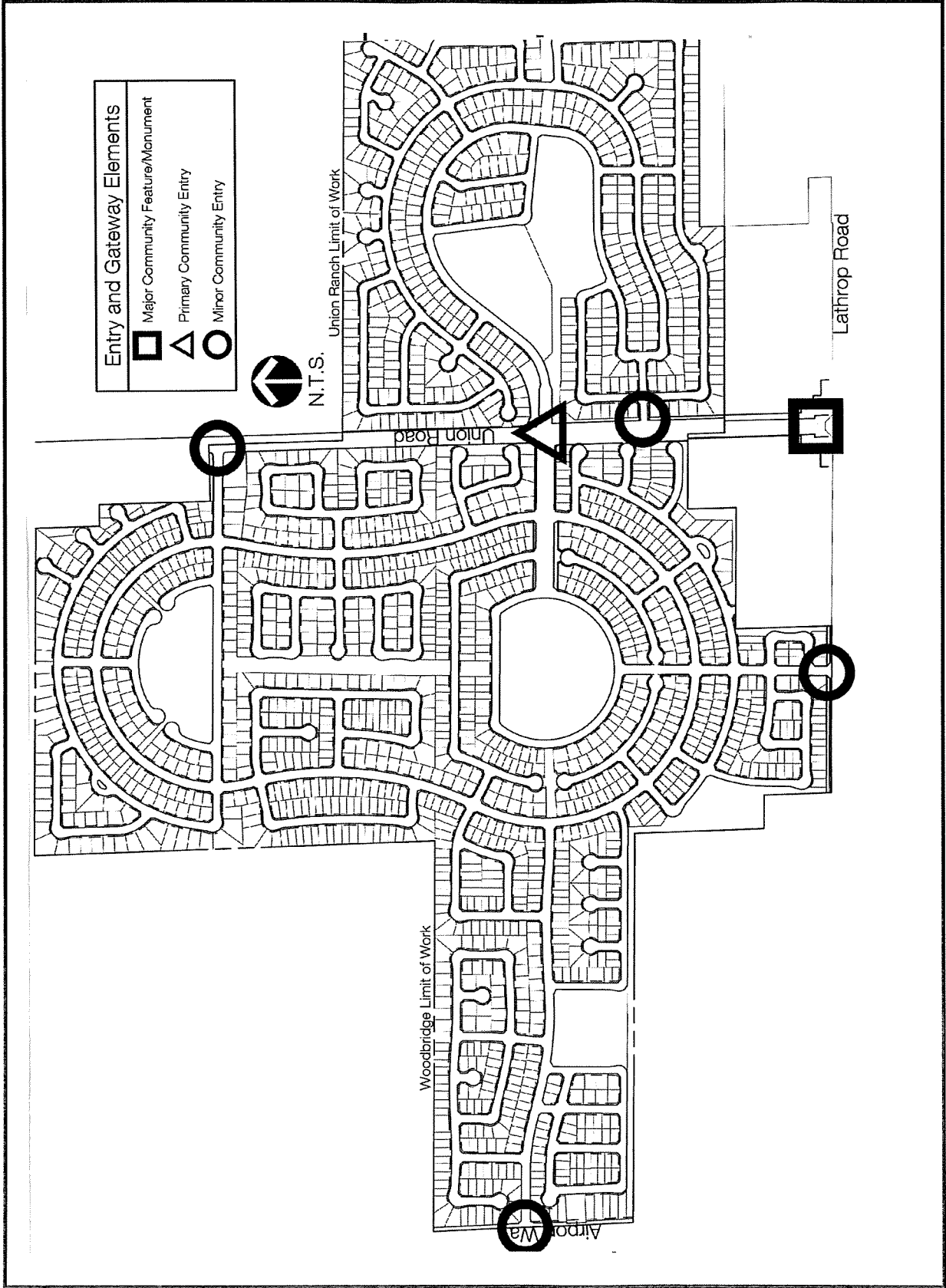

Figure J.8.1 Entry and Gateway Map

and objectives of the Design Guidelines are carried throughout the Union Ranch community. Standards that are equitable for all concerned will ensure protection of property values and architectural uniformity. Each entry monument or gateway element will highlight and strengthen the overall community design theme with a consistent material and landscape palette. A hierarchy of entry monuments and gateway elements has been established and are located as illustrated in Figure J.8.1. A summary is as follows:

### Major Community Entry

Located at the intersection of Union Road and W. Lathrop, the Major Community Entry will flank both sides of Union Road, with radiating sign walls complete with pilasters and pre cast concrete caps, signage, and plantings. This major entry and gateway feature will be the signature monument for the Union Ranch area and will also serve as the primary commercial entry as illustrated in Figure J.8.2.

Base materials and general components shall include, but are not limited to:

- Natural stone-like veneers on low decorative walls and pilasters;
- Dashed stucco and painted finish on sign walls;
- Rail fencing constructed of painted steel;
- Aluminum lettering for signage complete with an enamel paint finish;

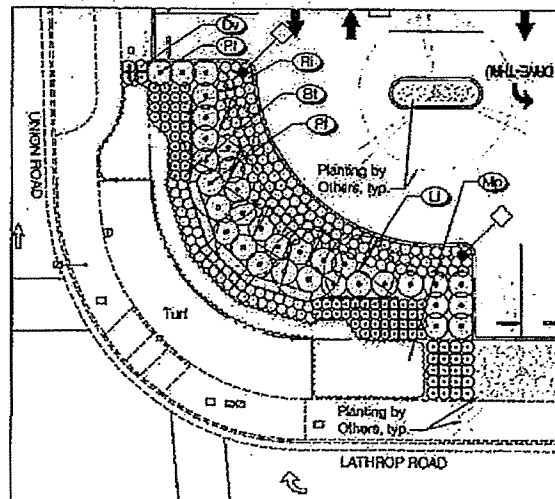
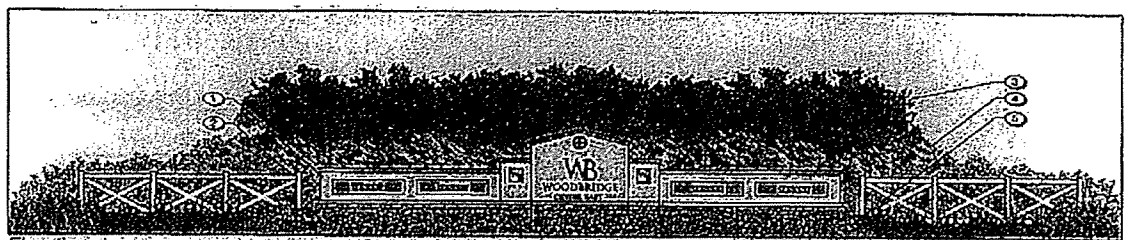

Plan View

Scale: 1" = 20'

- Landscape planting shall be layered with uniform ground plane plantings of a single species of evergreen and flowering plant material, massings of flowering shrub material in two or more layers, and accent tree plantings of flowering species reminiscent of an orchard environment;
- Sign wall lettering shall be up-lighted with ground- mounted fixtures. Lettering shall not be box or back lighted.

Primary Woodbridge Community Entry

Located along Union Road the Primary Community Entry to Woodbridge by Del Webb will flank both sides of Union Road, with radiating sign walls complete with pilasters with pre cast concrete caps, overhead arbors and lattice screens. Signage and lighting is also proposed as illustrated in Figure J.8.4.

Base materials and general components shall include, but are not limited to:

- Natural stone-like veneers on low decorative walls and pilasters;
- Dashed stucco and painted finish on sign walls;
- Rail fencing constructed of painted steel;
- Overhead arbors and lattice screens constructed of painted steel or aluminum. Wood shall not be used.
- Aluminum lettering for signage complete with an enamel paint finish;

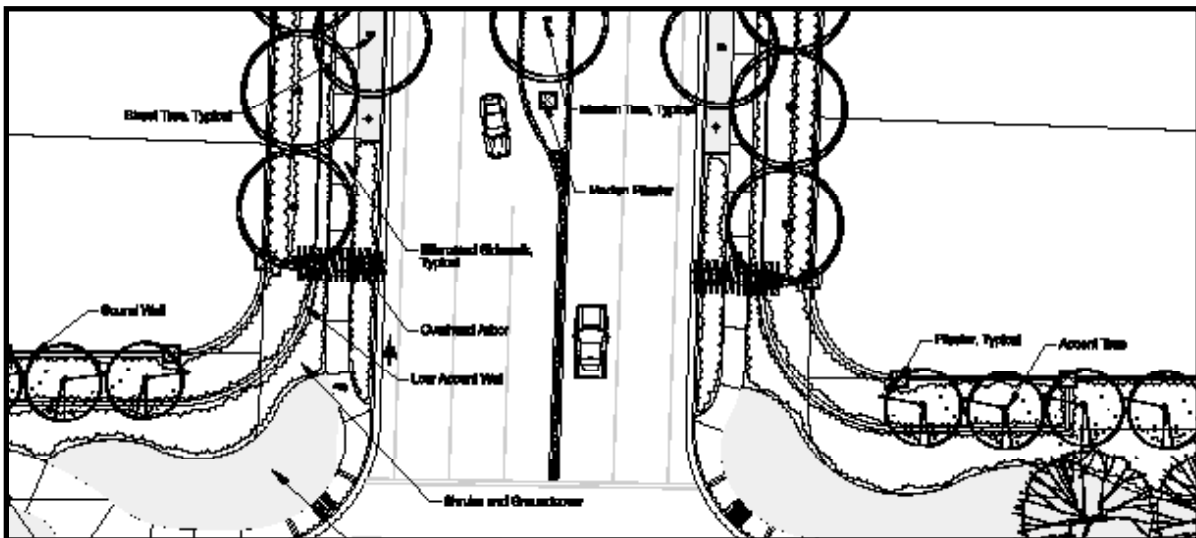

Figure J.8.4 Primary Woodbridge Entry Plan View

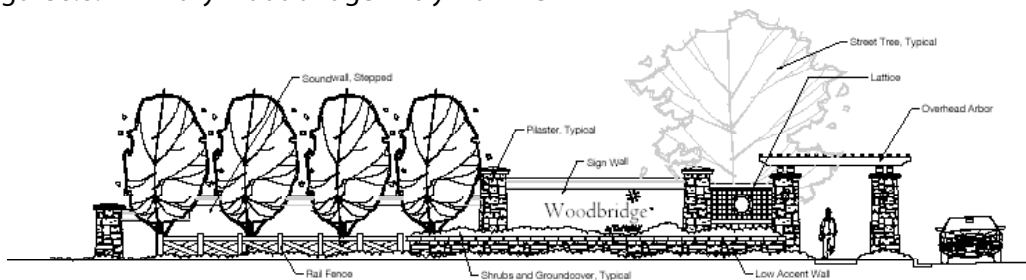

Figure J.8.5 Primary Woodbridge Entry Section

- Landscape planting shall be layered with uniform ground plane plantings of a single species of evergreen and flowering plant material, massings of flowering shrub material in two or more layers, and accent tree plantings of flowering species reminiscent of an environment;
- Sign wall lettering shall be up-lighted with ground-mounted fixtures. Lettering shall not be box or back lighted. Decorative lighting using carriage style fixtures shall be applied to each entry pilaster supporting the overhead arbor.

Primary Union Ranch East Community Entry

Located along Union Road the Primary Community Entry to Union Ranch East will flank both sides of Union Road, with a colonnade of pilaster supporting a trellis as the major signature feature. Low sign walls complete with pilasters with pre cast concrete caps will be placed on either side of the entry and will provide an opportunity for signage. A major bike trail connection will be made along the southern gateway as proposed and illustrated in Figure J.8.6.

Base materials and general components shall include, but are not limited to:

- Natural stone-like veneers on entry pilasters;
- Dashed stucco and painted finish on sign walls;
- Rail fencing constructed of painted steel;
- Overhead arbors to be constructed of painted steel or aluminum. Wood shall not be used.
- Aluminum lettering for signage complete with an enamel paint finish;

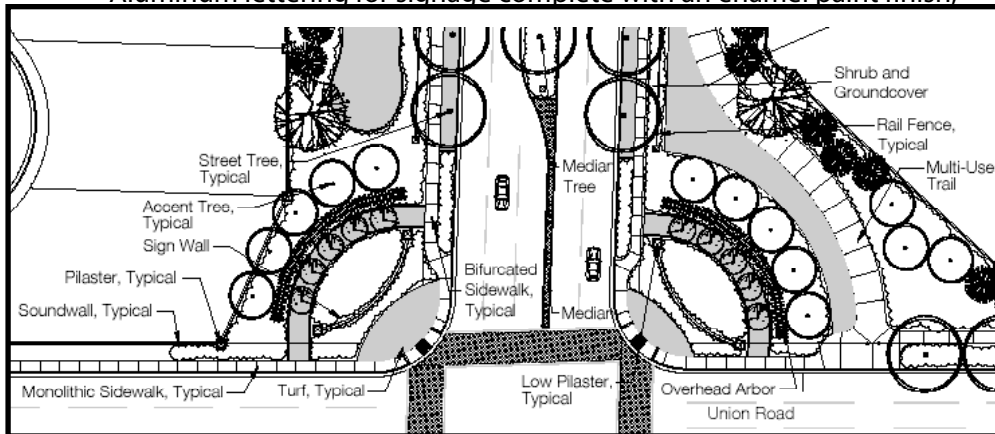

Figure J.8.6 Primary Union Ranch Entry Plan View

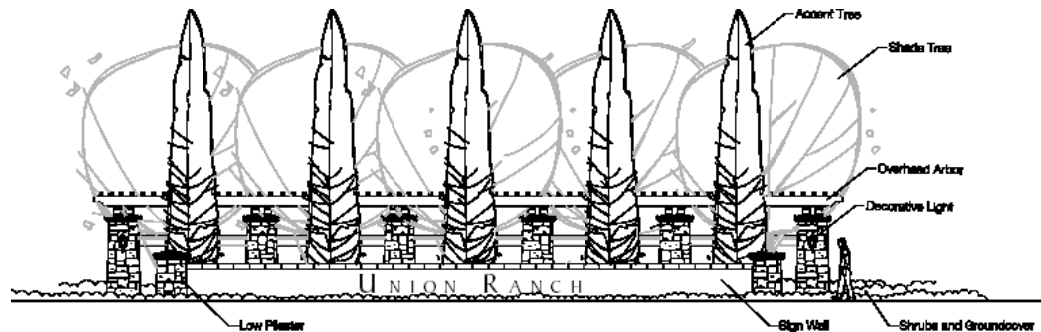

Figure J.8.7 Primary Union Ranch Entry Section

- Landscape planting shall be layered with uniform ground plane plantings of a single species of evergreen and flowering plant material, massings of flowering shrub material in two or more layers, and accent tree plantings of flowering species reminiscent of an environment;
- Sign wall lettering shall be up-lighted with ground- mounted fixtures. Lettering shall not be box or back lighted. Decorative lighting using carriage style fixtures shall be applied to each entry pilaster supporting the overhead arbor.

Secondary Woodbridge Community Entries

Typical secondary entries to Woodbridge shall be located on W. Lathrop Road, Airport Way, and on Union Road north of the primary Woodbridge entry. Smaller in scale than the primary entry they shall employ the same core elements and be fabricated of the same primary materials. Soundwalls shall have rounded at the corners at the entries and shall also form the sign walls. At the beginning and end of each curve a pilaster shall be placed. Pilasters shall have a stone-like veneer and pre cast cap as illustrated in Figure J.8.8.

Base materials and general components shall include, but are not limited to:

- Natural stone-like veneers on entry pilasters;
- Dashed stucco and painted finish on sign walls;
- Rail fencing constructed of painted steel;
- Aluminum lettering for signage complete with an enamel paint finish;

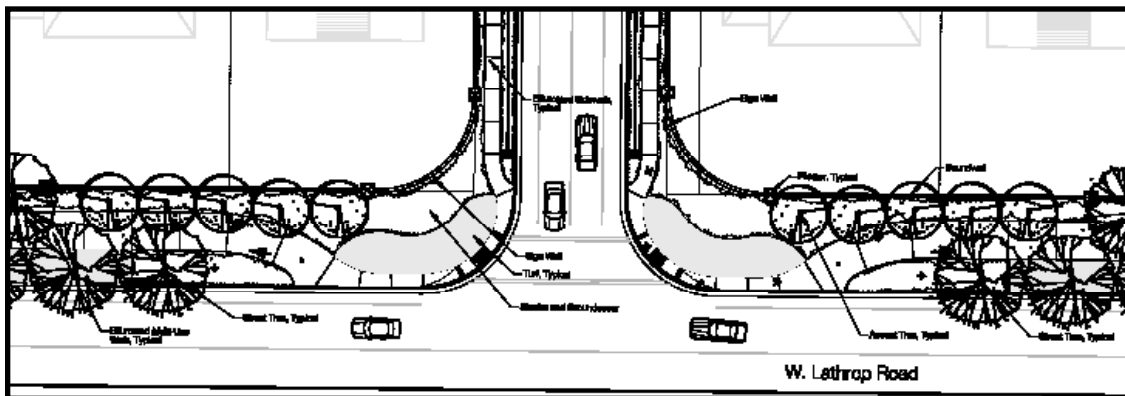

Figure J.8.8 Secondary Woodbridge Entry Plan View

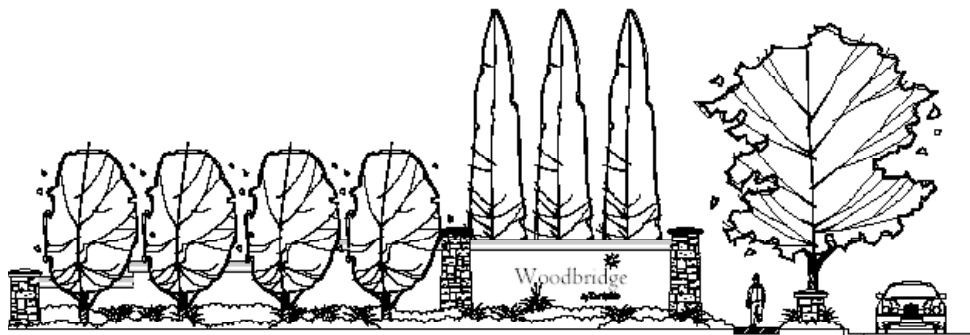

Figure J.8.9 Secondary Woodbridge Entry Section

- Landscape planting shall be layered with uniform ground plane plantings of a single species of evergreen and flowering plant material, massings of flowering shrub material in two or more layers, and accent tree plantings of flowering species reminiscent of an environment;
- Sign wall lettering shall be up-lighted with ground- mounted fixtures. Lettering shall not be box or back lighted.

Secondary Union Ranch Community Entry

A secondary entry to Union Ranch shall be located on Union Road north of the primary Union Ranch East entry. Smaller in scale than the primary entry it shall employ the same core elements and be fabricated of the same primary materials. Soundwalls shall have rounded corners at the entry and shall also form the sign wall. At the beginning and end of each curve a pilaster shall be placed. Pilasters shall have a stone-like veneer and pre cast cap as illustrated in Figure J.8.10.

Base materials and general components shall include, but are not limited to:

- Natural stone-like veneers on entry pilasters;
- Dashed stucco and painted finish on sign walls;
- Rail fencing constructed of painted steel;
- Aluminum lettering for signage complete with an enamel paint finish;

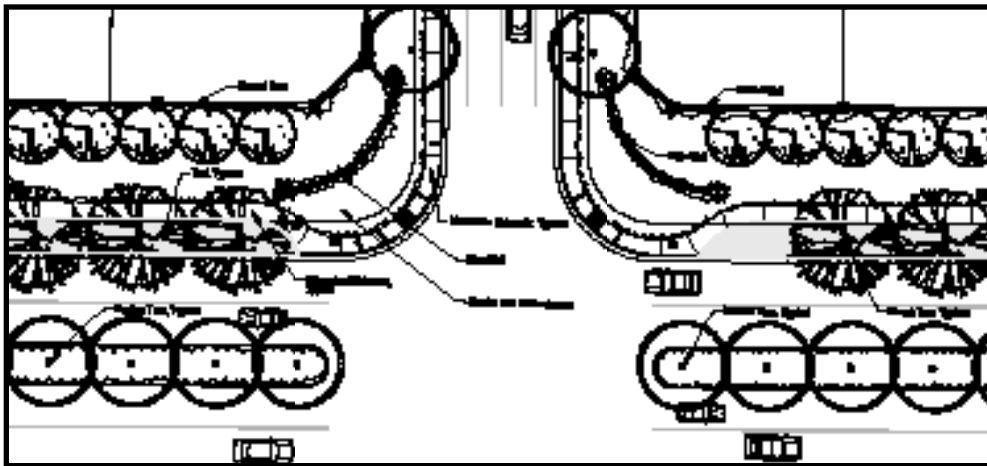

Figure J.8.10 Secondary Union Ranch Entry Plan View

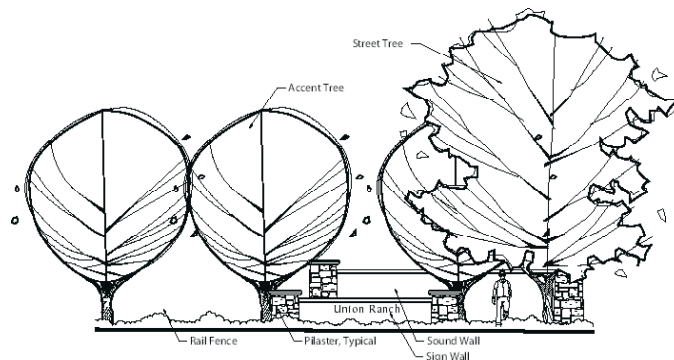

Figure J.8.11 Secondary Union Ranch Entry Section

- Landscape planting shall be layered with uniform ground plane plantings of a single species of evergreen and flowering plant material, massings of flowering shrub material in two or more layers, and accent tree plantings of flowering species reminiscent of an environment;
- Sign wall lettering shall be up-lighted with ground- mounted fixtures. Lettering shall not be box or back lighted.

### J.9 Signage

#### Major Community Entry

Lettering shall be computer cut aluminum with an acrylic paint finish. Lettering shall be surface mounted, and held a minimum of ½-inch off of face of wall to provide visual relief and shadow. Font shall be Centaur MT at the approximate sizing indicated in Figure J.9.1.

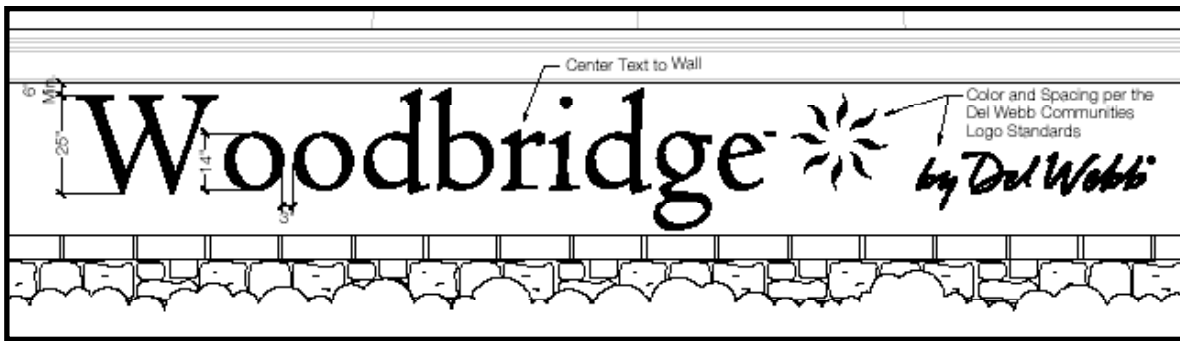

Figure J.9.1 Major Community Entry Signage

#### Primary Woodbridge Community Entry

Lettering shall be computer cut aluminum with an acrylic paint finish. Lettering shall be surface mounted, and held a minimum of ½-inch off of face of wall to provide visual relief and shadow. Font shall be Centaur MT at the approximate sizing indicated in Figure J.9.2.

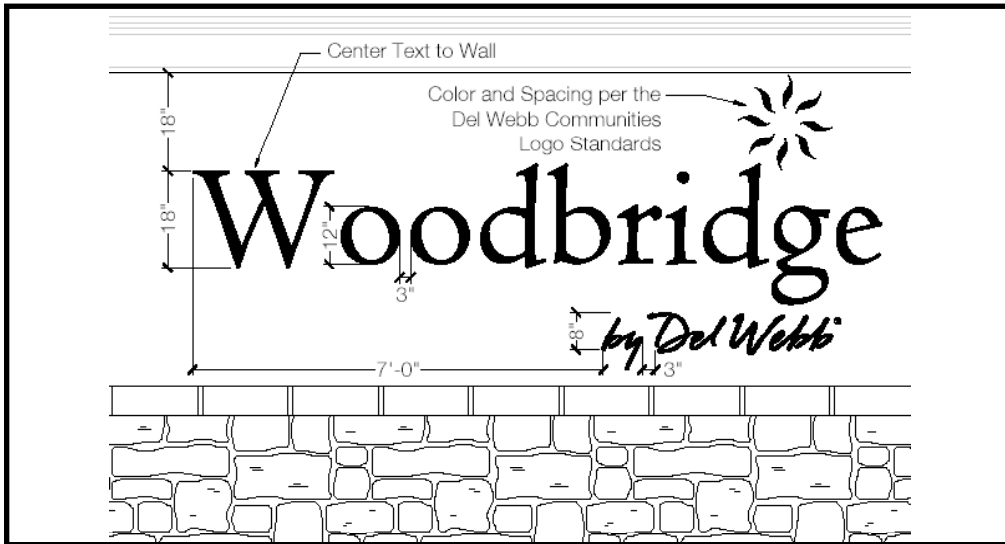

Figure J.9.2 Primary Woodbridge Community Entry Signage

Primary Union Ranch Community Entry

Lettering shall be computer cut aluminum with an acrylic paint finish. Lettering shall be surface mounted, and held a minimum of ½-inch off of face of wall to provide visual relief and shadow. Font shall be Baker Signet at the approximate sizing indicated in Figure J.9.3.

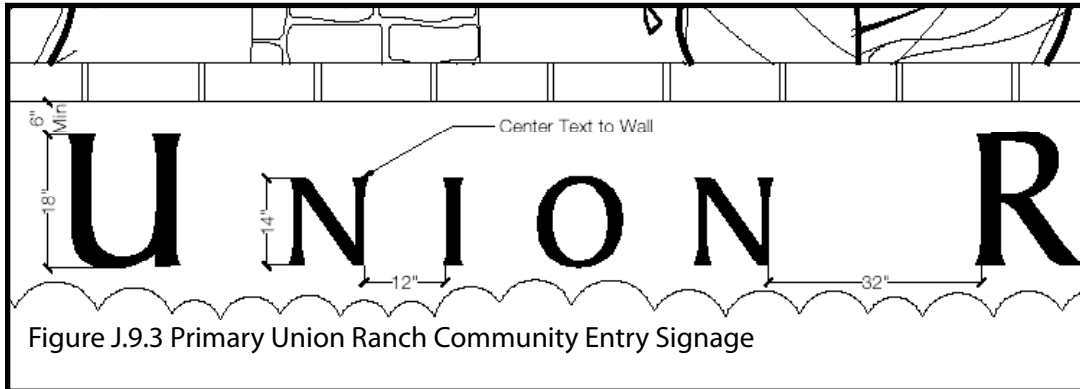

Figure J.9.3 Primary Union Ranch Community Entry Signage

Secondary Woodbridge Community Entry

Lettering shall be computer cut aluminum with an acrylic paint finish. Lettering shall be surface mounted, and held a minimum of ½-inch off of face of wall to provide visual relief and shadow. Font shall be Centaur MT at the approximate sizing indicated in Figure J.9.4.

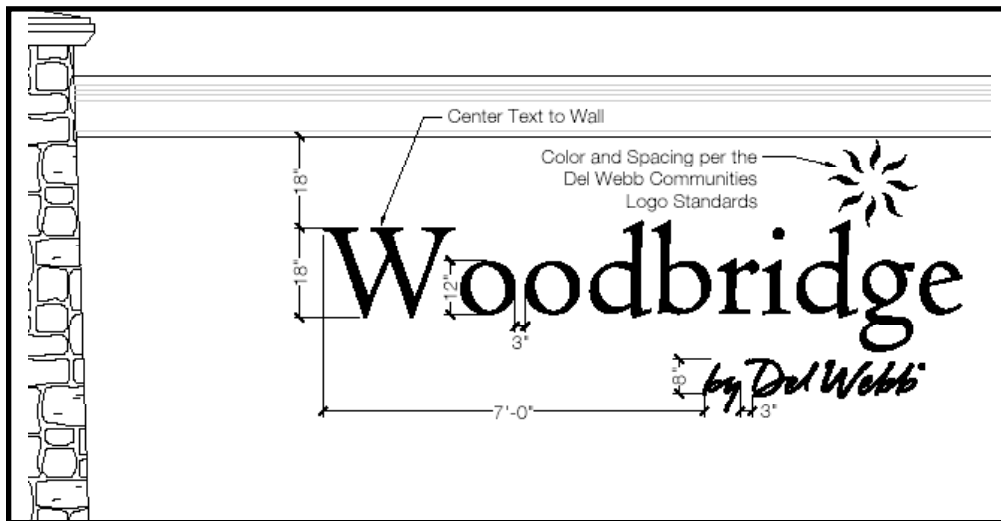

Figure J.9.4 Secondary Woodbridge Community Entry Signage

### Secondary Union Ranch Community Entry

Lettering shall be computer cut aluminum with an acrylic paint finish. Lettering shall be surface mounted, and held a minimum of ½-inch off of face of wall to provide visual relief and shadow. Font shall be Papyrus at the approximate sizing indicated in Figure J.9.5.

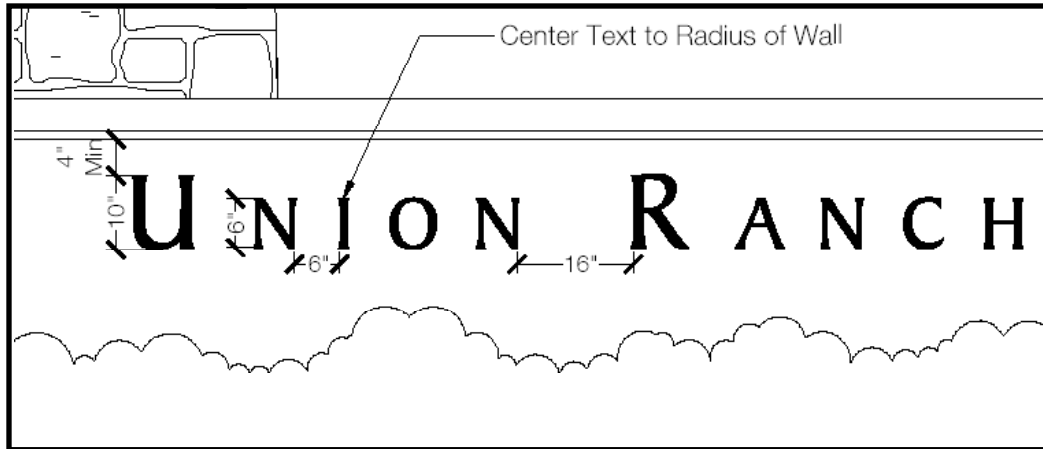

Figure J.9.5 Secondary Union Ranch Community Entry Signage

### CMU and Merchant Signage

All commercial signage, including gas station signage, and building and canopy signs shall conform to the requirements of the City of Manteca Municipal Code, Section 17, Zoning. The guidelines indicated in the following figures are for design reference only and are provided to ensure conformity to the community design theme.

#### a. Major Commercial Signage

One large free standing major commercial sign shall be permitted per aggregate of CMU parcels on either side of Union Road, for a total of two in the Plan Area. Signs shall be located outside the public right-of-way and shall not impede clear views for safe pedestrian and vehicular traffic. Signs shall be located a minimum of 200-foot clear of the intersections of W. Lathrop and Union Road, as dimensioned from back of curb on Union Road. Materials shall be consistent the elements described above, including stone-veneer at the base, pre-cast concrete caps for ledges and lintels, and stucco finish on field areas in colors to match the overall community palette. Interior illumination is permitted. See Figure J.9.6 for a general illustration.

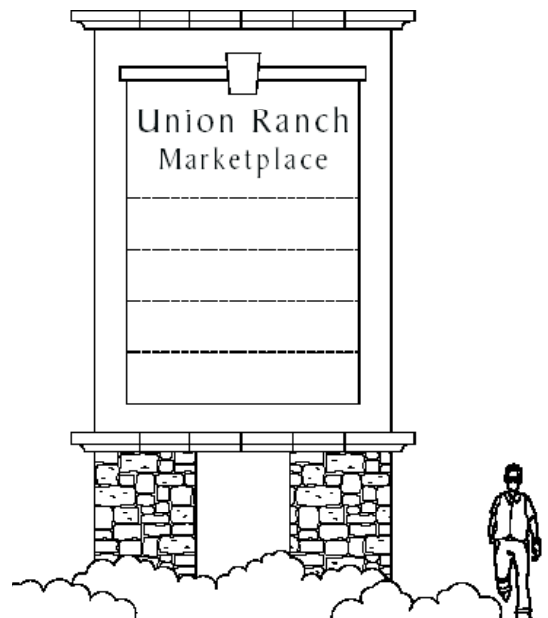

Figure J.9.6 Major Commercial Signage

b. Freestanding Commercial/Merchant Signage

One free standing commercial/merchant sign is permitted for each vehicular entry to the CMU parcels. Signs shall be located outside the public right-of-way and shall not impede clear views for safe pedestrian and vehicular traffic. Materials shall be consistent the elements described above, including stone-veneer at the base, pre-cast concrete caps for ledges and lintels, and stucco finish on field areas in colors to match the overall community palette. Interior illumination is permitted. See Figure J.9.7 for a general illustration.

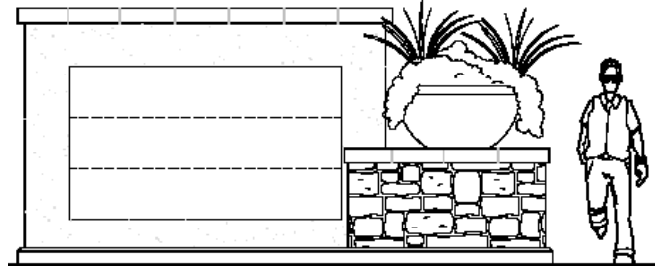

Figure J.9.7 Freestanding Commercial Signage

c. Price Sign (Gas Station)

One free standing price sign shall be permitted per gas station. Sign shall be located outside the public right-of-way and shall not impede clear views for safe pedestrian and vehicular traffic. Materials shall be consistent the elements described above, including stone-veneer at the base, pre-cast concrete caps for ledges and lintels, and stucco finish on field areas in colors to match the overall community palette. Interior illumination is permitted. See Figure J.9.8 for a general illustration.

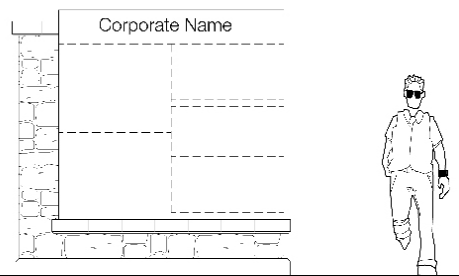

Figure J.9.8 Gas Station Signage

Public Street Signage & Traffic Signs

- a. Street signage will identify each street and shall be located at the intersections of all right-of-ways, including the multi-use paths located in greenways. Street signs shall be constructed of cast aluminum, black in color, with white reflective lettering. Poles shall be decorative, with traditional styling as illustrated by Figure 9.9.
- b. Traffic signs shall be installed as needed to conform to City and State traffic regulations. Poles shall be decorative cast aluminum to match public street signage, black paint finish
- c. Traffic signals, pole mounting and extension areas shall be constructed to City and State Standards. Paint finish shall be black to match Public Street Signage and Traffic Signs.

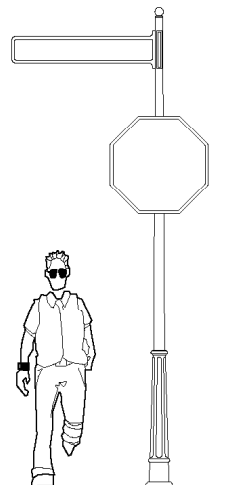

Figure J.9.9 Traffic Signs

Marketing Signs - Per City Sign Ordinance

These signs will identify the project from the major arterials. Refer to City of Manteca sign ordinance as it shall take precedence.

### Directional Signs - Per City Sign Ordinance

These signs shall provide on-site directional information to the location of the different residential projects. Refer to City of Manteca sign ordinance as it shall take precedence.

### Prohibited Signs

- a. Any signs located on vacant or unoccupied property that was erected for a business which no longer exists, or any sign which pertains to a time, event or purpose which no longer exists, shall be removed by the property owner within 7 days after the use has been abandoned.
- b. Signs constituting potential traffic hazard or which simulate or imitate in size, color, lettering or design any traffic sign or signal.
- c. Animated or moving signs: signs consisting of any moving, swinging, rotating, flashing, blinking or otherwise animated components.
- d. Roof signs: any sign erected, constructed and maintained upon or over the roof of any building, unless it is a projecting under-canopy sign.
- e. Other prohibited signs: advertising signs and billboards, inflatable signs or balloons, inflatable animals or similar signs.
- f. Window signs are allowed only in retail and commercial areas and are limited to a maximum of three square feet each, with the total window signage covering less than 10% of the window area. Examples of such permitted signs are open/closed, store hours, help wanted, sales, and other similar minor signs.

### Specialty Features

The Specialty Design Features of Union Ranch are reoccurring “signatures” throughout the Specific Plan Area and the application of such is proposed to provide a continuity of community design and integrity. Materials and finishes within the Plan Area shall conform to these general guidelines. A summary of the specialty features is as follows:

- Decorative or Enhanced Paving
- Streetscape Furnishings
- Public Lighting
- Sound Walls
- Pilasters and Low Decorative Walls
- Fencing

#### J.10 Decorative or Enhanced Paving

The use of decorative or enhanced paving is encouraged at pedestrian road crossings, major intersections of collector roads, at the entry to parks and CMU parcels, and at vehicle drop-offs and turnarounds. It is required in median nosing where the overall median width is less than three feet as measured from inside of curb. Decorative or enhanced paving shall be cast-in-

place stamped and integrally colored concrete, or concrete unit paving, in a herringbone pattern for field areas with a soldier course used for all border or perimeter paving.

### J.11 Streetscape Furnishings

A consistent palette of streetscape furniture is required throughout the Plan Area. This shall include, but is not limited to benches, trash receptacles, bicycle racks, and non-lighted bollards. Furniture shall be traditional in style, as illustrated in Figure J.11.1, and constructed of durable long lasting materials such as steel with powder coat paint finishes. Paint finishes in black are discouraged as is the use of wood construction. Acceptable colors include grey, forest green, or white.

### J.12 Public Lighting

Pedestrian scale lighting is required per City standards along all residential streets, including residential collectors, along multi-use paths in the greenways including the Tidewater Trail, and in the parks. Pole mounted fixtures are required as illustrated in Figure J.12.1 Pole mounted fixtures shall be metal with black painted finish. Similar style carriage-type fixtures are encouraged for wall-mounted

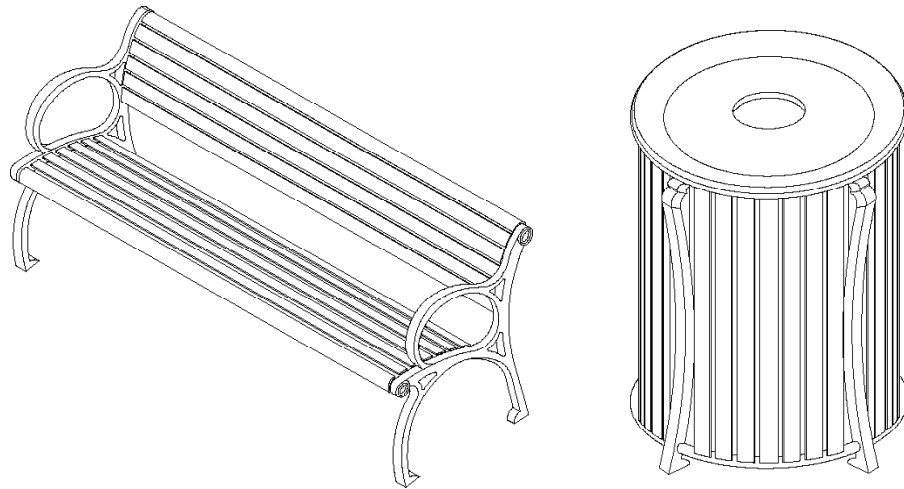

Figure J.11.1 Site Furnishings

lights in the CMU developments and private recreational facilities. Arterial streets shall be lighted using pole fixtures standard to the City of Manteca, with black paint finish.

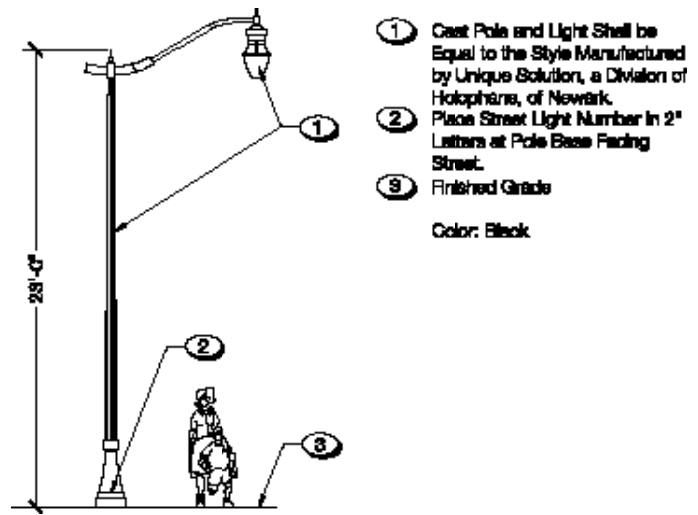

Figure J.12.1 Street Lights

### J.13 Soundwalls

Soundwalls are proposed to reduce the noise impact of adjacent roadways and to assist in defining the overall boundaries or limits of the Plan Area. Soundwalls shall serve as a visual and physical separation between land uses. The proposed soundwall for the entire Union Ranch community, including Woodbridge by Del Webb, shall be constructed of concrete masonry units placed on structurally sound concrete footings, and shall be reinforced and solid grout filled. (For the location of soundwalls, as well as typical fencing refer to Figure J.13.2. Typical soundwall height shall be seven feet as measured from the base of the wall at finish grade from either the residential side or the public right-of-way. Wall heights may vary. At typical community entries wall heights may be eight to ten feet for sign walls. In such cases the soundwall shall step down to seven foot in height within two hundred feet of any community entry. Walls along arterial roads shall be 10-feet high, but if placed on berms they may be reduced in height equal to the height of the berm. Refer to sound study prepared as a part of the EIR for more specific information.

Soundwalls shall be clipped or rounded as they approach residential lots, as illustrated in Figure J.8.4. Soundwalls shall be placed along property lines and shall not impede the view of pedestrians or vehicles at road crossing or other intersections.

### J.14 Pilasters and Low Decorative Walls

Decorative pilasters and low (non-structural) walls shall be constructed of concrete masonry units, placed on structurally sound concrete footings. Stone veneer shall be Cultured Stone, San Francisco Cobblefield by Stone Products Corporation (CSV-2036), or equal. Mortar color shall match. Stone veneer shall be applied per

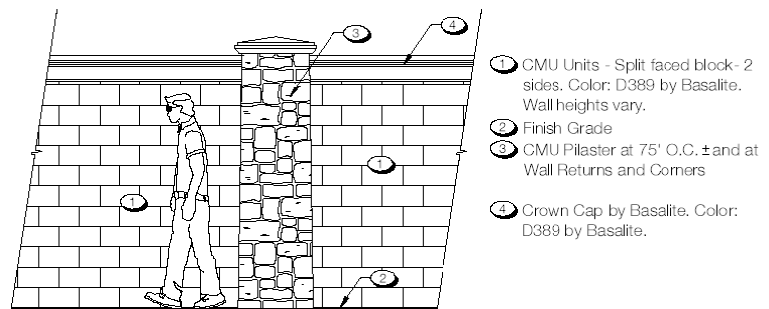

Figure J.13.1 Soundwalls

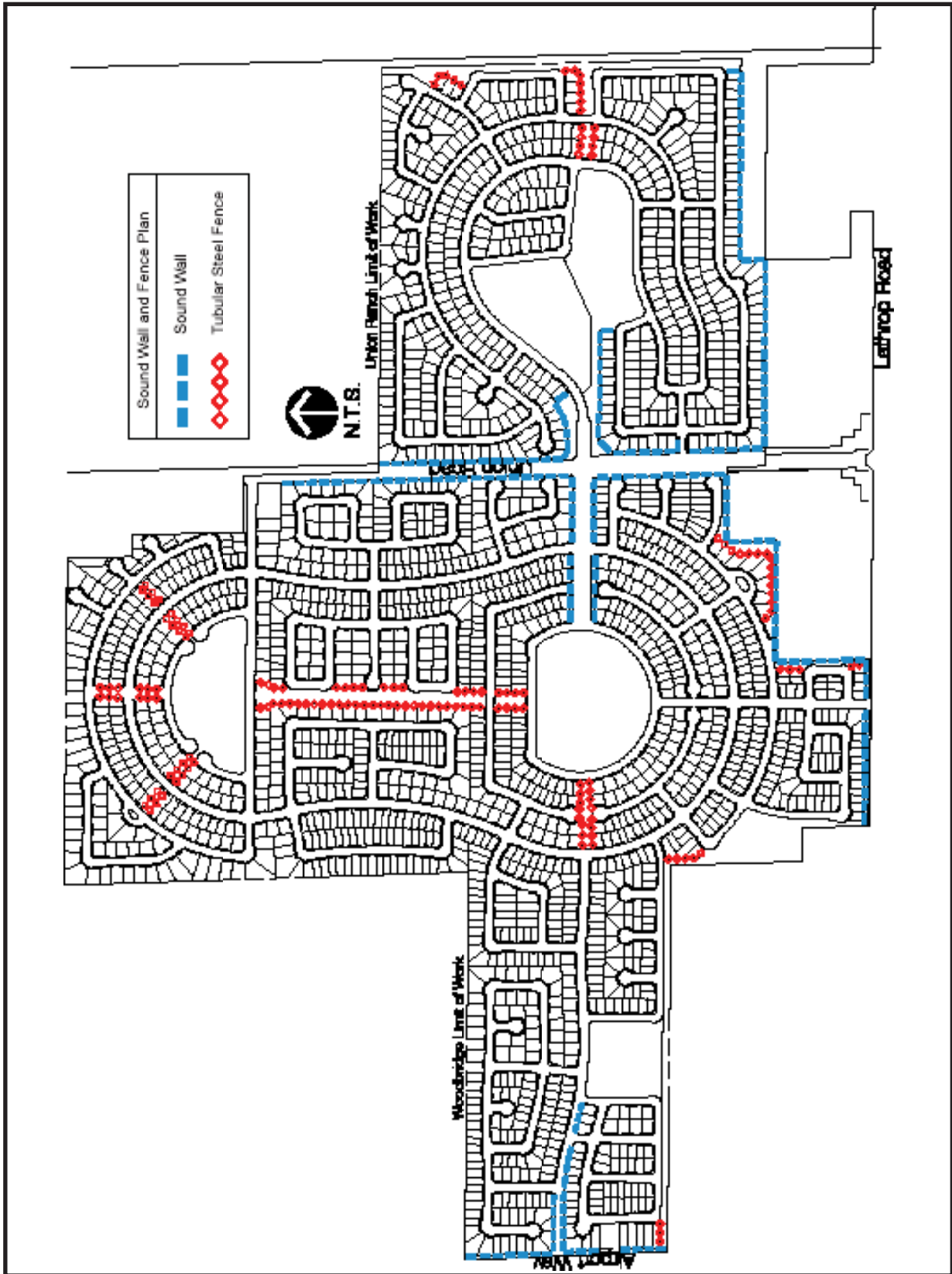

Figure J.13.2 Soundwall and Fencing Map

manufacturer's instructions. Pilaster caps shall be pre-cast integral color concrete, mortared in place. Low walls shall have stone veneer chiselled wall cap (Cultured Stone), Gray AS-1201 by Stone Products Corporation, or equal.

Pilasters shall be located at the beginning or terminus of all soundwalls, or changes in direction. In-wall placement of pilasters shall occur every 100-feet, or closest proximity thereof. Finishes shall be on all four sides. Low decorative walls are typically found at community entries, or within public right-of ways. Refer to Figure J.14.1 for a general illustration of a typical pilasters and low wall arrangement.

### J.15 Fencing

Four fencing types are proposed for Union Ranch.

- a. Decorative View Fence- Constructed of tubular steel with a black painted finish, as illustrated in Figure J.15.1. The decorative view fence is preferred to be located at rear and/or side yards

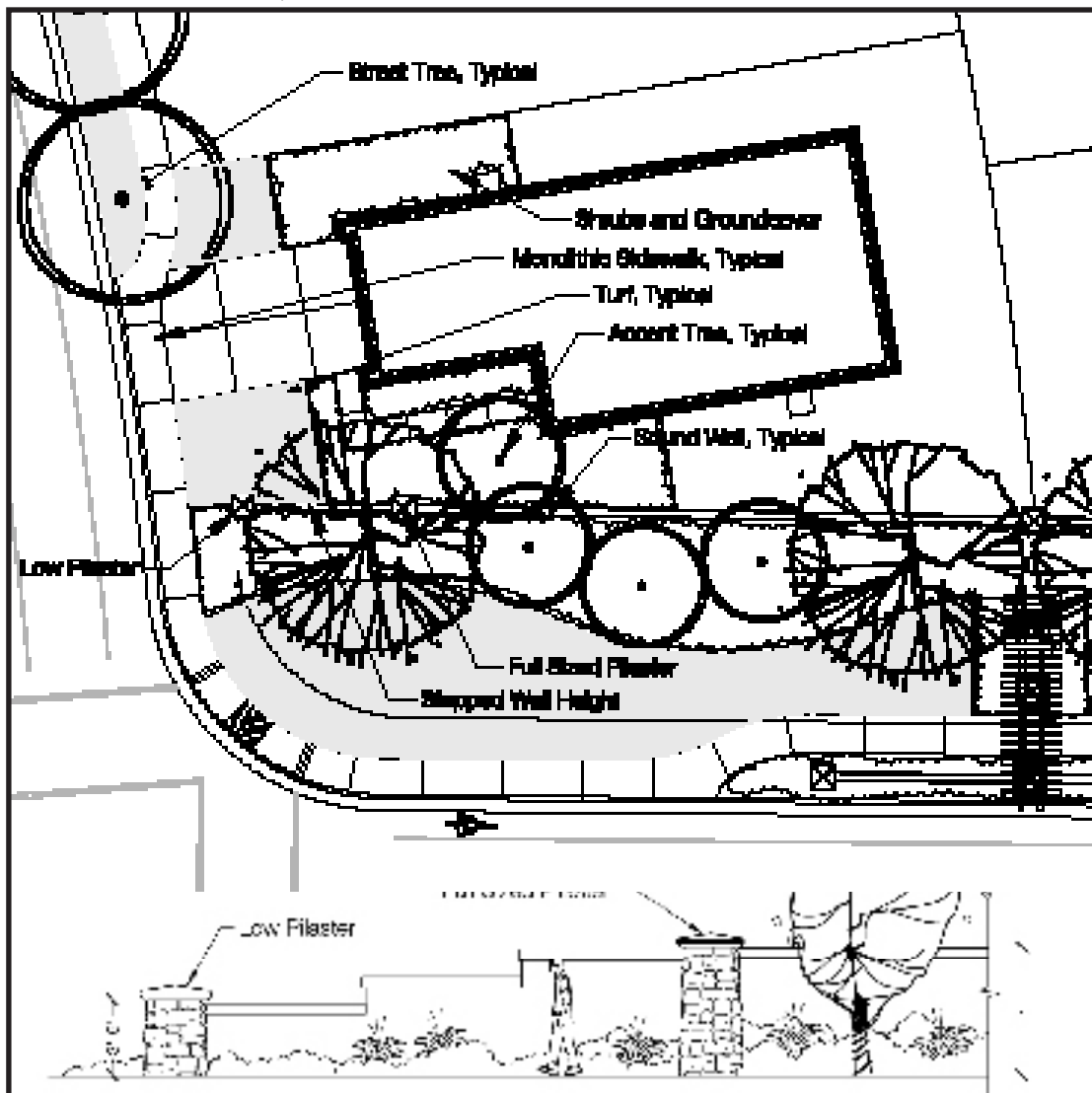

Figure J.14.1 Soundwall and Pilaster Diagram, Plan & Section

backing on to greenways and open space areas, as indicated in Figure J.13.2. 2" x 2" posts shall be secured in the ground with a concrete footing; top and bottom rails shall be a minimum of 1" in size, and pickets shall be a minimum 3/4-inch. (SPPA 12-91-01)

- b. Low Accent Fence - The low accent fence shall be a rail type fence, reminiscent of a traditional farm fence, as illustrated in Figure J.15.2. Constructed of tubular steel with a gray/white paint white finish the rail fence shall be typically used at community entries and adjacent to sign walls, as well as in public right-of-ways.
- c. Front, Side Yard, and Rear Fence - Constructed of wood or vinyl, the typical

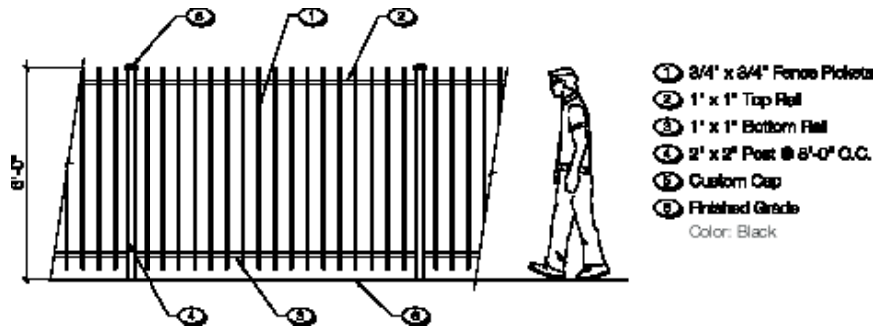

Figure J.15.1 Decorative View Fence

fence shall be used to separate residential rear and side yards. All wood fencing shall receive a minimum of two coats of semi-transparent stain, Mushroom #910 by Olympic Stain, or equal.

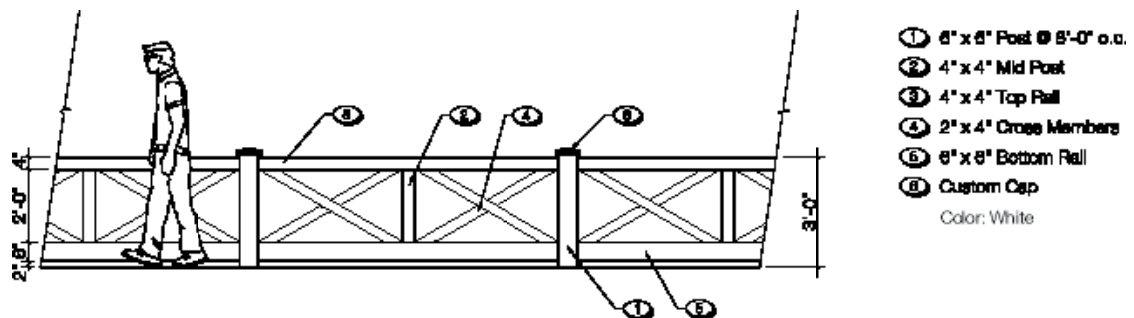

Figure J.15.2 Low Accent Fencing

### J.16 Landscape Palette

The landscape palette developed for the Union Ranch Specific Plan has been developed to insure a cohesive element of design throughout the community. The proposed plant palette is designed to achieve a strong delineation of street rights-of-way, corresponding landscape

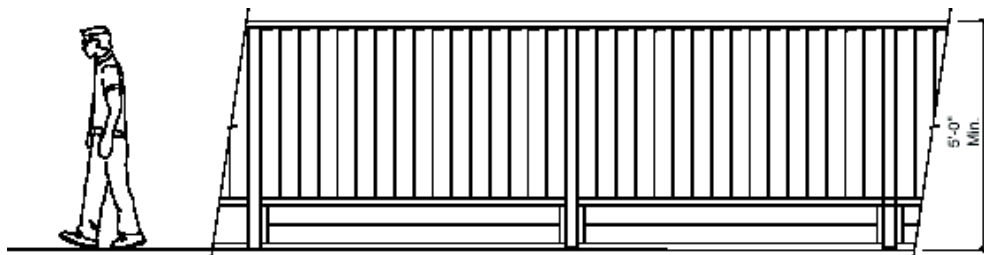

Figure J.15.3 Front, Side Yard, and Rear Fence

---

easements, open space corridors, greenways, and community focal points. Basic criteria for the selection and use of specific plant material is as follows:

- 1) All proposed plant material has been selected for its compatibility with the environmental conditions of Manteca.
- 2) Plant material selection and planting locations will consider the site, relationships to building structures, and solar/climatic orientation as well as utilizing water-wise materials and practices for water conservation.
- 3) Plant material selections for project perimeters, streetscapes, intersections, parks, open spaces are to be achieved with those plants listed in the corresponding plant palette.
- 4) All installed plant materials will be located to provide clear views for traffic and public safety.
- 5) All installed landscapes will be irrigated by an automatic irrigation system utilizing water-conserving design.
- 6) All trees will be a minimum twenty-four inch (24) box container size, unless specified otherwise. All shrub plantings will contain a fifty (75) percent minimum of five (5) gallon container size plant material, and the balance one (1) gallon container size plant material.

#### J.16.1 Master Plant Palette

The Master Plant List, as found in Appendix A.1, for Union Ranch itemizes the intended plant palette. It is recognized that market conditions may affect availability. Substitutions, although not encouraged, may be approved based upon characteristics most similar to those materials indicated on the master Plant List.

#### J.17 Soil Conditioning Guidelines

- 1) Existing topsoil from grading, road excavations and other building development should be stockpiled for future placement in designated landscape areas. These soils will be amended and used as backfill as a planting media.
- 2) It is required that landscape installations reflect amendment for fertility per the requirements of a soils fertility testing to be completed prior to construction.

#### J.18 Irrigation Improvements Criteria

Given the quantity of landscaped open spaces within the Union Ranch Specific Plan Area, water conservation will be an important long-range factor. For this reason, the following recommendations shall be addressed in the development of irrigation improvements.

- 1) The increased use of shrub and groundcover materials, in-lieu of large open turf areas, will create the opportunity for drip, modified-drip and bubbler flood irrigation improvements as opposed to spray/surface irrigation techniques.
- 2) Rain sensors are required in order to eliminate excessive watering or irrigation operation during rainfall events.
- 3) All installed landscapes will be irrigated by an automatic irrigation system utilizing water-conserving design.

---

## J.19 Landscape Maintenance

The landscape areas, whether owned by public agencies or private developments, shall be maintained to the highest possible standards of reasonable care. Without proper maintenance the major community elements, and associated landscapes, may deteriorate affecting the overall aesthetic qualities that this document is promoting. The intent of the landscape maintenance guidelines is to give direction for the standards of maintenance for all landscape areas in all land uses throughout the community. Proper horticultural practices must be utilized on a site-by-site basis.

These maintenance guidelines apply to all land use designations except for low density, residential, median density residential and public/quasi public land uses.

### J.19.1 Turf Care

1) Mowing/Edging

Cool season grasses such as ryegrass, and fescues will be mowed at least once every seven (7) days during the growing season and as needed during the cold, rainy seasons. Mowing heights will 2-2.5 inches in spring/summer and 1.5-2 inches in fall/winter. All clippings will be disposed of off-site. Large turf areas in parks may mulched directly back to source.

2) Watering

Turf areas will be watered at such frequency, as weather conditions require, to replenish soil moisture below the root zone. Watering shall always be done at night by an electrically controlled irrigation system. Water moisture sensing devises will be used as part of the irrigation control system. Water runoff across pavements and into gutters will be avoided.

3) Fertilization

Lawns will be fertilized with a total of at least six (6) pounds of actual nitrogen per 1,000 square feet per year. The number of applications and type of nitrogen used will depend upon appropriate fertilizer formulation based on individual site and seasonal conditions. If soil PH drops below 6.0, then a basic fertilizer such as calcium nitrate may be preferable to an acidic fertilizer. A soil fertilization analysis recommendation shall be followed when deficiencies appear.

4) Weed, Pest, and Disease Controls

Qualified personnel will make regular inspection of turf areas for pests and diseases. Approved herbicides will be applied to control broadleaf weeds. Early spring applications of a pre-emergent herbicide will be used for crabgrass control. Post-emergent applications for crabgrass will be applied prior to germination.

5) Chemical Controls

Qualified personnel under the supervision of a licensed applicator will apply all chemical controls.

6) Aerification

---

Aerify all compacted turf areas to improve water penetration whenever required.

7) Trash Control

Remove all trash and other debris from landscape areas weekly.

### J.19.2 Tree and Shrub Care

Maintain trees and shrubs in a healthy, growing condition by performing all necessary operations including the following:

1) Pruning

- a. Prune trees and shrubs in a healthy, growing condition by performing all necessary operations including the following:
- b. Select and develop permanent scaffold branches that are smaller in diameter than the trunk or branch to which they are attached.
- c. Maintain vertical spacing of eighteen to forty-eight (18-48) inches with a radial orientation so as not to overlay one branch to another.
- d. Eliminate diseased or damaged growth and narrow V-shaped branch forks that lack strength.
- e. Reduce toppling and wind damage by thinning out crowns.
- f. Under no circumstances will stripping of lower branches ("raising up") of young trees be permitted. Lower branches will be retained in a "tipped back" or "pinched" condition with as much foliage as possible to promote caliper trunk growth (tapered trunk). Lower branches will be cut flush with the trunk only after the tree is able to stand erect without staking or other support.
- g. Evergreen trees will be thinned out and shaped when necessary to prevent wind and storm damage. The primary pruning of evergreen trees will be done during the dormant season. Damaged trees, or those which constitute health or safety hazards, will be pruned at any time of the year as required.
- h. Shrubs – The objectives of shrub pruning are the same as for trees. Shrubs will not be clipped into balled or boxed forms unless such is required by the design.
- i. Staking and Guying – When trees attain a trunk caliper of two (2) inches, remove existing stakes and guys. If unstable at this time, replacement will be recommended to the owner. Stakes and guys are to be inspected at least two (2) times per year to prevent rubbing which causes bark wound. Adjust tree stakes, ties, and guy lines as required.

2) Weed Control

Keep basins and areas between plants free of weeds. All trees in lawns will have a twenty-four (24) inch diameter circle of open soil maintained around the base of the trunk. This will encourage tree vigor and minimize damage to tree trunks and roots by machinery. Use recommended, legally approved, herbicides to control growth in this open area. Avoid frequent soil cultivation, which destroys shallow roots and breaks the seal of pre-emergent herbicides.

### 3) Insect and Disease Control

Regular inspection of trees and shrubs for pests and diseases will be performed. Apply chemical control as required.

### 4) Fertilization

Fertilize recently established plants as needed, but at least annually for trees, and four (4) times per year for shrubs, with a soluble nitrate fertilizer.

Avoid applying fertilizer to the rootball and base of main stem; rather, spread evenly under plant's dripline. Rates will vary from about a cup of nitrate fertilizer (depending on nitrogen percentage) around a newly installed small plant to about one-half (1/2) pound of actual nitrogen per inch of trunk diameter measure four (4) feet from the ground for mature trees.

### 5) Watering

Plants should not be watered until a moisture check has been made of representative plants in the landscape. The need for water will dictate the frequency of watering by an automatic irrigation system.

For areas not under irrigation, maintain a large enough water basin around the plants so enough water can be applied to establish moisture through the major root zone. When hand watering, a water wand shall be used to break the water force. In the rainy season open basins to allow surface drainage away from the root crown where excess water may accumulate.

## J.19.3 Ground Cover Care

Foster attractiveness at all times by the following:

#### 1) Weed Control

Control weeds, preferably with pre-emergent herbicides, but also with selected systemic or contact herbicides and hand labor. Hoe weeds as little possible since this may result in plant damage.

#### 2) Fertilization

Apply five (5) pounds of actual nitrogen per year, in four (4) applications, during the first year of a new planting or if the ground cover is showing signs of nitrogen starvation. One (1) application will be in early spring when growth begins. Reduce to three (3) pounds actual nitrogen in following years, or as needed to maintain vigorous growth and good color. Complete fertilizers are not necessary unless soil test shows specific nutrient deficiencies.

#### 3) Watering

Water enough that moisture penetrates throughout the root zone and only as frequently as necessary to maintain healthy growth.

#### 4) Trash Control

Remove trash from landscape areas on a weekly basis.

#### J.19.4 Annual Flower Beds

Annual flowers should be replaced four (4) times per year with annuals according to the season. Soil will be thoroughly prepared prior to planting by incorporating slow-release fertilizer, which encourages proper flowering. Nitrified redwood soil conditioners, or similar materials, will be added for improving soil conditions.

#### J.19.5 Irrigation System

Maintenance contractors will inspect and adjust sprinkler heads, valves, and controllers on a regular basis for proper operation. All irrigation heads will be adjusted as required for unimpeded coverage and to eliminate overspray onto sidewalks, walls, etc.

Automatic controllers shall be set and programmed for seasonal water requirements.

#### J.19.6 Hardscape Care

All hardscape shall be maintained in a neat and attractive appearance throughout the year by following these practices:

- 1) Decorative paving shall be pressure washed at least two times during the dry season and checked for unsafe conditions. Litter and other debris shall be removed on a weekly basis. Landscape areas that “wash out” onto paving shall be corrected at the first evidence of a problem.
- 2) Any and all graffiti which may appear on walls or other hardscape elements, including those associated with utilities, shall be removed immediately. Walls and fences shall be planted with trailing vines to cover exposed surfaces to deter graffiti.

## Appendix A.1

<b>Streetscape Plantings</b>			
BOTANICAL NAME	COMMON NAME	NOTES	SIZE
<b>Primary Street Trees-Backbone</b>			
Liriodendron tulipifera	Tulip Tree		24" Box
Prunus cerasifera 'Thundercloud'	Purple Leaf Plum		24" Box
Quercus virginiana	Southern Live Oak		24" Box
Zelkova serrata "Village Green"	Village Green Zelkova		24" Box
<b>Secondary Street Tree-Backbone</b>			
Magnolia grandiflora	Southern Magnolia		24" Box
Pinus canariensis	Canary Island Pine		24" Box
Prunus cerasifera 'Thundercloud'	Purple Leaf Plum		24" Box
Sequoia sempervirens 'Soquel'	Coast Redwood		24" Box
<b>Major Accent Trees- Entries</b>			
Magnolia grandiflora	Southern Magnolia		60- 72" Box
Quercus agrifolia	Coast Live Oak	Multi & Standard	72" Box
<b>Accent Tree- Backbone &amp; Entries</b>			
Betula pendula	Weeping European Birch		24" Box
Carpinus betulus 'Fastigiata'	Pyramidal European Hornbeam		24" Box
Laurus X saratoga	Saratoga Laurel		24" Box
Lagerstroemia X fauriei	Crape Myrtle var.	Multistem	24" Box
Pistacia chinensis	Chinese Pistache		24" Box
Prunus cerasifera 'Thundercloud'	Purple Leaf Plum		24" Box
<b>Shrubs</b>			
Agapanthus africanus "Peter Pan"	Peter Pan Agapanthus		1 gallon
Agapanthus africanus 'Queen Anne'	Queen Ann Agapanthus		5 gallon
Berberis thunbergii 'Crimson Pygmy'	Crimson Pygmy Barberry		5 gallon
Dietes vegeta	Fortnight Lily		5 gallon
Hemerocallis 'Stello D'Oro'	Stello D'Oro Daylily		1 gallon
Hypericum moseranum	Gold Flower		5 gallon
Juniperus chinensis 'Aurea'	Gold Coast Juniper		5 gallon

Nerium oleander	Dwarf Oleander		5 gallon
Phormium 'Bronze Baby'	Bronze Baby New Zealand Flax		5 gallon
Phormium tenax 'Atropurpureum'	Purple New Zealand Flax		15 gallon
Pittosporum tobira 'Variegata'	Variegated Mock Orange		5 gallon
Photinia x fraserii	Photinia		5 gallon
Prunus laurocerasus 'Otto Luyken'	Otto Luyken English Laurel		5 gallon
Raphiolepis indica 'Ballerina'	Ballerina Indian Hawthorn		5 gallon
Raphiolepis indica 'Jack Evans'	Jack Evans Indian Hawthorn		5 gallon
Rhamnus californica 'Eve Case'	Eve Case Coffeeberry		5 gallon
Rosa HT var.	Hybrid Tea Roses (TBD)		5 gallon
Tulbaghia violacea	Society Garlic		5 gallon
<b>Groundcover/Vines</b>			
Ficus pumila	Creeping Fig		5 gallon
Juniperus horizontalis 'Plumosa'	Andorra Juniper		5 gallon
Parthenocissus tricuspidata	Boston Ivy	Staked	5 gallon
Rosa, var.	Groundcover/Climbing Roses		5 gallon
Rosmarinus officinalis 'Huntington Carpet'	Huntington Carpet Rosemary		1 gallon
Trachelospermum jasminoides	Star Jasmine		1 gallon

<b>Clubhouse Planting</b>			
BOTANICAL NAME	COMMON NAME	NOTES	SIZE
<b>Trees at Del Webb Recreation Center</b>			
Betula pendula	Weeping European Beech		24" Box
Chaemaerop humilis	Mediterranean Fan Palm	3-4' Clumps	24" Box
Lagerstroemia X fauriei	Crape Myrtle var.	Multi & Standard	24" Box
Liriodendron tulipifera	Tulip Tree		24" Box
Prunus cerasifera 'Thundercloud'	Purple Leaf Plum		24" Box
Quercus virginiana	Southern Live Oak		24" Box
Trachycarpus fortunei	Windmill Palm		24" Box
Washingtonia robusta	Mexican Fan Palm		24" Box
Zelkova serrata "Village Green"	Village Green Zelkova		24" Box
<b>Parking Lot Shade Trees</b>			
Fraxinus oxycarpa 'Raywood'	Raywood Ash		15 Gallon
Ulmus Parvifolia 'True Green'	Chinese Evergreen Elm		24" Box
<b>Shrubs/Groundcovers</b>			
Agapanthus africanus "Peter Pan"	Peter Pan Agapanthus		1 gallon
Agapanthus africanus 'Queen Anne'	Queen Ann Agapanthus		5 gallon
Berberis thunbergii 'Crimson Pygmy'	Crimson Pygmy Barberry		5 gallon
Camellia sasanqua	Camellia var. (TBD)		5 gallon
Coprosma pumila 'Verde Vista'	Mirror Plant		5 gallon
Cycas revoluta	Sago Palm		15 gallon
Dietes vegeta	Fortnight Lily		5 gallon
Festuca ovina 'Glauca'	Blue Fescue		1 gallon
Hypericum moserianum	Gold Flower		5 gallon
Juniperus chinensis 'Aurea'	Gold Coast Juniper		5 gallon
Lavendula stoechas	Spanish Lavender		5 gallon
Memecocallis hybrids	Daylily		1 gallon
Miscanthus sinensis	Maidenhair Grass		5 gallon
Nerium oleander	Dwarf Oleander		5 gallon
Phormium 'Bronze Baby'	Bronze Baby New Zealand Flax		5 gallon
Pittosporum tobira 'Wheeler's Dwarf'	Wheeler's Dwarf Mock Orange		5 gallon
Prunus laurocerasus 'Otto Luyken'	Otto Luyken English Laurel		5 gallon

---

Raphiolepis indica 'Ballerina'	Ballerina Indian Hawthorn		5 gallon
Raphiolepis indica 'Jack Evans'	Jack Evans Indian Hawthorn		5 gallon
Rosa HT var.	Hybrid Tea Roses (TBD)		5 gallon
Rosa, var.	Groundcover/Climbing Roses		5 gallon
Rosmarinus officinalis 'Tuscan Blue'	Rosemary		5 gallon
Trachelospermum jasminoides	Star Jasmine		1 gallon
Tulbaghia violacea	Society Garlic		5 gallon

<b>Front Yard Typical Planting</b>			
BOTANICAL NAME	COMMON NAME	NOTES	SIZE
<b>Residential Street Trees</b>			
Acer rubrum 'Sunset'	Sunset Red Maple		24" Box
Platanus acerifolia 'Bloodgood'	London Plane Tree		24" Box
Sophora japonica 'Regent'	Japanese Pagoda Tree		24" Box
Tilia cordata 'Greenspire'	Greenspire Linden		24" Box
Ulmus parvifolia 'True Green'	True Green Elm		24" Box
<b>Residential Accent Trees</b>			
Acer palmatum	Japanese Maple		15 gallon
Arbutus marinia	NCN	Multistem	15 gallon
Magnolia soulangeana	Saucer Magnolia		15 gallon
Lagerstroemia x fauriei	Crape Myrtle	Multistem	15 gallon
Sequoia sempervirens	Costal redwood		15 gallon
<b>Shrubs/Groundcovers/Vines</b>			
Agapanthus africanus "Peter Pan"	Peter Pan Agapanthus		1 gallon
Azalea 'Southern Indica'	Azelea var.		5 gallon
Camellia japonica	Camellia var. (TBD)		5 gallon
Dietes vegeta	Fortnight Lily		5 gallon
Ficus pumila	Creeping Fig	Staked	5 gallon
Hemerocallis Evergreen var.	Evergreen Daylily		1 gallon
Lavendula stoechas	Spanish Lavender		5 gallon
Liriope gigantea	Giant Lilyturf		1 gallon
Parthenocissus tricuspidata	Boston Ivy	Staked	5 gallon
Phormium 'Bronze Baby'	Bronze Baby New Zealand Flaz		5 gallon
Prunus laurocerasus 'Otto Luyken'	Otto Luyken English Laurel		5 gallon
Raphiolepis indica 'Ballerina'	Ballerina Indian Hawthorn		5 gallon
Raphiolepis indica 'Jack Evans'	Jack Evans Indian Hawthorn		5 gallon
Rhamnus californica 'Eve Case'	Eve Case Coffeeberry		5 gallon
Rosa, var.	Groundcover Roses		5 gallon
Trachelospermum jasminoides	Star Jasmine		1 gallon